

R&S® PR100 Portable Receiver Manual



© 2008 Rohde & Schwarz GmbH & Co. KG

81671 Munich, Germany

Printed in Germany – Subject to change – Data without tolerance limits is not binding.

R&S® is a registered trademark of Rohde & Schwarz GmbH & Co. KG.

Trade names are trademarks of the owners.

The following abbreviations are used throughout this manual:

R&S® PR100 is abbreviated as R&S PR100.

Index:

| | |
|---|----|
| Index: | 3 |
| 1 Performance Check | 8 |
| 1.1 Symbols and safety labels | 9 |
| 1.2 Tags and their meaning | 9 |
| 1.3 Basic safety instructions | 10 |
| 2 Quality certificate | 12 |
| 3 EC certificate | 13 |
| 4 Support center address | 14 |
| 5 Operating principle | 15 |
| 6 Set-up | 20 |
| 6.1 Front view | 20 |
| 6.2 Top view | 21 |
| 6.3 Unpacking the instrument | 21 |
| 6.4 Setting up the instrument | 22 |
| 6.5 Inserting the battery | 23 |
| 6.6 Connecting to the power supply | 23 |
| 6.7 Charging the Battery | 24 |
| 6.8 Switching on the monitoring receiver | 25 |
| 6.9 Ambient and operating conditions | 26 |
| 6.10 Preventive maintenance | 26 |
| 6.11 Monitoring receiver connectors | 26 |
| 6.12 Software update | 33 |
| 6.12.1 Option code activation | 34 |
| 7 Configuration Menus | 35 |
| 7.1 RX Configuration Menu | 35 |
| 7.1.1 General | 35 |
| 7.1.2 Antenna (only with option Field Strength Measurement) | 39 |
| 7.1.3 Tone | 41 |
| 7.1.4 Measure | 42 |
| 7.1.5 BFO (CW only) | 44 |
| 7.1.6 Direct Conversion Threshold | 45 |
| 7.1.7 Inputs / Outputs | 45 |
| 7.2 Scan Configuration Menu | 46 |
| 7.2.1 Frequency Scan | 46 |
| 7.3 Memory Scan | 48 |
| 7.3.1 Scan Options | 50 |
| 7.4 Display | 53 |
| 7.4.1 RX Screen | 53 |
| 7.4.2 IF-PAN Screen | 54 |
| 7.4.3 RF-PAN Screen | 56 |
| 7.4.4 Waterfall Screen | 57 |
| 7.5 General Configuration Menu | 60 |
| 7.5.1 General | 60 |
| 7.5.2 Local Settings | 61 |
| 7.5.3 Display | 62 |
| 7.5.4 Keys | 62 |
| 7.5.5 Audio | 64 |

| | | |
|---------|---|-----|
| 7.5.6 | LAN | 66 |
| 7.6 | Memory Configuration Menu | 69 |
| 7.6.1 | Direct Save & Auto Save | 69 |
| 7.7 | Antenna Configuration Menu | 71 |
| 8 | SCPI Interface | 72 |
| 8.1 | Document Outline | 72 |
| 8.2 | Legend | 72 |
| | Abbreviations Used | 72 |
| 9 | SCPI Commands | 73 |
| 9.1 | SCPI introduction | 73 |
| 9.1.1 | Common Command Structure | 74 |
| 9.1.2 | Device-Specific Command Structure | 74 |
| 9.1.3 | Structure of a command line | 75 |
| 9.1.4 | Responses to queries | 76 |
| 9.1.5 | Parameters | 77 |
| | Syntax Elements | 79 |
| 9.2 | Status Reporting | 79 |
| | Structure of an SCPI status register | 80 |
| 9.2.1 | Description of the status registers | 83 |
| 9.2.2 | Use of the Status Reporting System | 91 |
| 9.2.3 | Resetting values of the status reporting system | 93 |
| 9.3 | Error Messages | 93 |
| 9.4 | Commands Description | 98 |
| 9.4.1 | Notation | 98 |
| 9.4.2 | Common Commands | 99 |
| 10 | Instrument Behaviour | 101 |
| 10.1 | Error Situations | 102 |
| 10.2 | Ranging and Rounding | 102 |
| 10.3 | Value Representation | 103 |
| 10.4 | Default Values | 103 |
| 10.5 | Instrument States | 103 |
| 10.5.1 | Introduction | 103 |
| 10.5.2 | MR States | 103 |
| 11 | Commands Reference | 106 |
| 11.1 | Common Commands | 106 |
| 11.2 | ABORt subsystem | 107 |
| 11.3 | CALCulate subsystem | 107 |
| 11.4 | DIAGnostic subsystem | 112 |
| 11.5 | DISPlay subsystem | 113 |
| 11.6 | FORMat subsystem | 132 |
| 11.7 | INITiate subsystem | 135 |
| 11.8 | INPut subsystem | 137 |
| 11.9 | MEASure subsystem | 138 |
| 11.10 | MEMory subsystem | 140 |
| 11.10.1 | Memory list subsystem | 147 |
| 11.10.2 | Memory save subsystem | 149 |
| 11.11 | MMEMory subsystem | 152 |
| 11.12 | OUTPut subsystem | 160 |
| 11.13 | Program preset subsystem | 173 |
| 11.14 | SENSe Subsystem | 176 |
| 11.14.1 | Sense Memory Scan subsystem MSC | 201 |

| | | |
|---------|---|-----|
| 11.14.2 | Sense Panorama Scan subsystem PSC | 211 |
| | Sense Frequency Scan subsystem SWE..... | 217 |
| 11.15 | STATus subsystem | 224 |
| 11.16 | SYSTEM subsystem | 229 |
| 11.17 | TRACe DATA subsystem | 246 |
| 11.18 | TRACe DATA:UDP subsystem | 259 |
| 12 | UDP Data Streams | 266 |
| 12.1 | Stream Packet Structure..... | 266 |
| 12.2 | Audio | 270 |
| 12.3 | FScan | 272 |
| 12.4 | MScan | 274 |
| 12.5 | CW | 275 |
| 12.6 | IFPan..... | 276 |
| 12.7 | IF | 277 |
| 12.8 | PSCAN | 279 |
| 13 | Default Values | 282 |
| | CALCulation subsystem | 282 |
| 13.1 | DISPlay subsystem | 282 |
| 13.2 | FORMat subsystem | 283 |
| 13.3 | INPut subsystem | 283 |
| 13.4 | MEASurement subsystem | 283 |
| 13.5 | MEMory subsystem..... | 283 |
| 13.6 | OUTPut subsystem | 283 |
| 13.7 | SENSE subsystem | 283 |
| 13.8 | STATus subsystem | 284 |
| 13.9 | SYSTEM subsystem | 284 |
| 13.10 | TRACe subsystem | 284 |

1 Performance Check

Before using the product for the first time, please read the following:



Rohde & Schwarz makes every effort to maintain the most stringent safety standards as regards its products and to guarantee its customers the highest possible level of safety. Our products and the necessary auxiliary equipment are designed and tested in accordance with the relevant safety standards. Compliance with these standards is continuously monitored by our quality assurance system. This product has been designed and tested in accordance with the EC Certificate of Conformity and has left the manufacturers' plant in a condition that complies fully with safety standards. To maintain this condition and to ensure safe operation, please take note of all the instructions and warnings appearing in this manual. Should you have any questions regarding these safety instructions Rohde&Schwarz will be happy to answer them.







Furthermore, you are responsible for using the product in an appropriate manner. This product is designed solely for use in industrial and laboratory environments, or in the field, and must not be used in any way that may cause personal injury or damage to property. The user bears responsibility if the product is used for any purpose other than that for which it was designed or if the manufacturer's instructions are disregarded. The manufacturer accepts no liability for misuse of the product.

The product is considered as being used for its designated purpose where it is used in accordance with the relevant operating manual and within its performance limits (see data sheet, documentation, the following safety instructions). Using the products requires technical skills and a knowledge of English. It is therefore essential for the products to be used only by skilled and specialized staff or thoroughly trained personnel with the required skills. Should personal protective equipment be necessary for using R&S products, this will be indicated at the appropriate place in the product documentation.

1.1 Symbols and safety labels

Symbole und Sicherheitskennzeichnungen

| | | | | | | | |
|---|---|---|---|--|---|---|---|
|  |  |  |  |  |  |  |  |
| Bedienungs- anleitung beachten | Vorsicht bei Geräten mit einer Masse > 18kg | Gefahr des elektrischen Schlages | Warnung ! heiße Oberfläche | Schutzleiter- anschluss | Erd- anschluss | Masse- anschluss | Achtung! Elektrostatisch gefährdete Bauelemente |

| | | | | | |
|---|---|---|---|---|---|
|  |  |  |  |  |  |
| Versorgungs- spannung EIN/AUS | Anzeige Stand-by | Gleichstrom DC | Wechselstrom AC | Gleich- Wechselstrom DC/AC | Gerät durchgehend durch doppelte/verstärkte Isolierung geschützt |

Compliance with safety instructions will help prevent personal injury or damage caused by hazards of any kind. It is therefore essential to carefully read and comply with the following safety instructions before commissioning the product. It is also absolutely vital to comply with additional safety instructions relating to personal safety which appear in other sections of the documentation. In these safety instructions, the word "product" refers to all goods sold and distributed by Rohde&Schwarz, including all instruments, systems and accessories.

1.2 Tags and their meaning

| | |
|------------------|--|
| DANGER | Indicates a hazard area that carries a high risk of danger for users. The hazard area can cause death or serious injuries. |
| WARNING | Indicates a hazard area that carries a medium risk of danger for users. The hazard area can cause death or serious injuries. |
| CAUTION | Indicates a hazard area that carries a slight risk of danger for users. The hazard area can cause minor injuries. |
| ATTENTION | This tag indicates the possibility of incorrect use which may cause damage to the product. |
| NOTE | This tag indicates a situation where the user should take special care when operating the product but which will not damage the product. |

1.3 Basic safety instructions

1. The product should be operated only under the operating conditions and in the situations specified by the manufacturer; its ventilation must not be obstructed during operation. Unless otherwise specified, the following requirements apply to R&S products: IP protection 2X, pollution level 2, excess voltage category 2, for indoor use only, maximum operating altitude 2000 meters above sea level
2. Applicable local or national safety regulations and accident prevention rules must be observed when performing any operations. The product should only be opened by authorized, specially trained personnel. Prior to carrying out any work on the product or opening the product, it must be disconnected from the mains power supply. Any adjustments, replacement of parts, maintenance or repairs must only be carried out by specialist electricians authorized by R&S. Original parts only should be used to replace safety-related components (e.g. power switches, power transformers or fuses). A safety test must always be carried out after safety-related components have been replaced (visual inspection, ground/earth test, insulation resistance and leakage current measurements, function test).
3. As with all manufactured goods, the use of substances that may cause an allergic reaction (allergens), such as aluminum, cannot be ruled out. Should you develop an allergic reaction (such as a skin rash, frequent sneezing, red eyes or breathing difficulties) when using R&S products, consult a doctor immediately to determine the cause.
4. For certain functions, some products, such as HF radio equipment, can produce a high level of electromagnetic radiation. Given that unborn children require increased protection, appropriate measures should be taken to protect pregnant women. People with pacemakers may also be harmed by electromagnetic radiation. Employers are required to assess workplaces where there is a specific risk of exposure to radiation and, where necessary, take measures to avert the danger.
5. Special training and a high level of concentration is needed to operate the products. Disabled people should only use the products if it is certain that there will be no impairment due to the nature of their disability when operating the products.
6. Before switching on the product, ensure that the rated voltage setting on the product matches the rated voltage of the mains supply. The product's mains fuse should also be changed if it is necessary to alter the voltage setting.
7. In the case of safety class I products with a flexible power cord and connector, operation is only permitted using sockets with an earth/ground contact and a protective earth/ground connection.
8. Intentionally breaking the protective earth/ground connection, either in the feed line or in the product itself, is not permitted; doing so may result in an electric shock hazard from the product. Where extension cables or connector strips are used, they must be checked on a regular basis to ensure that they are safe to use.
9. If the product is not equipped with a power switch for disconnection from the mains supply, the plug on the connecting cable is to be regarded as the disconnecting device. In such cases, you must ensure that the mains plug can be easily reached and is accessible at all times (length of the connecting cable approx. 2m). Function or electronic switches are not suitable for disconnecting the mains supply. If products

without a mains switch are integrated into racks or systems, a disconnecting device must be provided at the system level.

10. Never use the product if the power cable is damaged. Take appropriate safety measures and carefully lay the power cable to ensure that the latter cannot be damaged and that no one can be hurt, for example by tripping over the cable or receiving an electric shock.

11. The product may be operated only from TN/TT mains power networks with a maximum 16A fuse.

12. Do not insert the plug into sockets that are dusty or dirty. Insert the plug firmly and all the way into the socket, otherwise there is a risk of sparks, fire and/or injury.

13. Do not overload any sockets, extension cables or connector strips; doing so may cause fire or electric shocks.

14. For circuit measurements with V_{rms} voltages above 30V, suitable measures (e.g. appropriate measuring equipment, fuses, current limiting, electrical separation, insulation, etc.) should be taken to avoid any hazards.

15. Ensure that any connections with computer equipment comply with IEC950/EN60950.

16. Never remove the cover or part of the housing while you are operating the product. This will expose circuits and components and may cause injury, fire or damage to the product.

17. If a product is to be permanently installed, the earth/ground connection on site and the product's earth/ground conductor must be connected before any other connection is made. The product must only be installed and connected by a specialist electrician.

18. For permanently installed equipment without built-in fuses, circuit breakers or similar protective devices, the mains circuit must be fuse-protected in such a way that users and products are sufficiently protected.

19. Do not insert any objects which are not designed for this purpose into the openings on the housing. Never pour any liquids onto or into the housing. This may cause a short circuit inside the product and/or electric shocks, fire or injury.

20. Take appropriate measures to protect against excess voltage caused by adverse weather conditions (e.g. thunderstorms) reaching the product, otherwise, operating personnel will be exposed to the risk of electric shocks.

21. R&S products are not protected against water penetration unless otherwise specified (see Point 1). If this is not observed there is a risk of electric shocks or damage to the product, which may also result in personal injury.

22. Never use the product in conditions where condensation has formed or may form in or on the product, for example when the product is moved from a cold to a warm environment.

23. Do not obstruct any slots or openings on the product, since these are necessary for ventilation and prevent the product from overheating. Do not place the product on

surfaces that are not rigid, such as sofas or carpets, or inside a closed housing, unless this is well ventilated.

24. Do not place the product on equipment that generates heat, such as a radiator or fan heater. The ambient temperature must not exceed the maximum temperature specified in the data sheet.

25. Batteries and storage batteries must not be exposed to high temperatures or fire. Store batteries and storage batteries out of the reach of children. If batteries or storage batteries are not replaced appropriately there is a risk of explosion (warning: lithium cells). Batteries and storage batteries must only be replaced with the corresponding R&S type batteries (see spare parts list). Batteries and storage batteries are classed as hazardous waste. Dispose of them only in specially marked containers. Comply with local regulations concerning waste disposal. Do not short-circuit batteries or storage batteries.

26. Please be aware that in the event of a fire, the product may emit toxic gases that can be harmful to your health.

27. Be aware of the weight of the product. Move the product carefully, as its weight may cause back or other physical injuries.

28. Do not place the product on surfaces, vehicles, cabinets or tables whose weight and stability make them unsuitable for this product. Always follow the manufacturer's installation instructions when installing the product and attaching it to objects or structures (e.g. walls and shelves).

29. Should you decide to use the product inside a vehicle, it is the sole responsibility of the driver to drive the vehicle safely. Secure the product properly inside the vehicle to prevent injury or damage in the event of an accident. Never use the product in a moving vehicle if doing so may distract the driver of the vehicle. The driver is always responsible for the safety of the vehicle; the manufacturer assumes no responsibility for accidents or collisions.

30. If a laser product (e.g. a CD/DVD drive) is integrated into an R&S product, do not use any settings or functions other than those described in the documentation. This may otherwise be hazardous to your health, since lasers may cause irreversible optical damage. Never attempt to take such products apart. Never look directly into the laser beam.

2 Quality certificate

Dear Customer,

Thank you for purchasing a Rohde & Schwarz product.

This product is manufactured using state-of-the-art production methods. It is developed, produced and tested in accordance with the rules of our Quality Management System. The Rohde & Schwarz Quality Management System is ISO 9001 certified.

Certified Quality System
ISO 9001
DQS REG. NO 1954-04

3 EC certificate



KONFORMITÄTSERKLÄRUNG gemäß dem Gesetz über Funkanlagen und Telekommunikationsendeinrichtungen (FTEG) und der Richtlinie 1999/5/EG (R&TTE)
DECLARATION OF CONFORMITY in accordance with the Radio and Telecommunications Terminal Equipment Act (FTEG) and Directive 1999/5/EC (R&TTE Directive)



Zertifikat-Nr. / Certificate No : 2008-05

Hiermit wird bescheinigt, dass die Funkanlage
 This is to certify that the Radio equipment

| Gerätetyp Equipment Type | Materialnummer Stock No | Benennung Designation |
|-----------------------------|----------------------------|--|
| PR100 | 4071.9006.02 | Portable Receiver 9 kHz - 7.5 GHz |

Geräteklasse: / Equipment class: 1 7 (Receive-only radio equipment)

bei bestimmungsgemäßer Verwendung den grundlegenden Anforderungen des § 3 und den übrigen einschlägigen Bestimmungen des FTEG (Artikel 3 der R&TTE) entspricht.
 complies with the essential requirements of §3 and the other relevant provisions of the FTEG (Article 3 of the R&TTE Directive) when used for its intended purpose

- Gesundheit und Sicherheit gemäß § 3 (1) 1 (Artikel 3 (1) a))
 Health and safety requirements pursuant to § 3 (1) 1 (Article 3(1) a))
- Schutzanforderungen in Bezug auf die elektromagn. Verträglichkeit § 3 (1) 2, Artikel 3 (1) b))
 Protection requirements concerning electromagnetic compatibility § 3(1)(2), (Article 3(1)(b))
- Maßnahmen zur effizienten Nutzung des Funkfrequenzspektrums
 Measures for the efficient use of the radio frequency spectrum
- Luftschnittstelle bei Funkanlagen gemäß § 3(2) (Artikel 3(2))
 Air interface of the radio systems pursuant to § 3(2) (Article 3(2))

Angewendete harmonisierte Normen:
 Harmonised standards applied:

EN 61010-1 : 2001
 ETSI EN 301489-1 V1 6.1 (2005-09)
 ETSI EN 301489-22 V1.3 1 (2003-11)
 EN 55022:1998+A1:2000+A2:2003,
 Klasse B

Einhaltung der grundlegenden Anforderungen auf andere Art und Weise (hierzu verwendete Standards/Spezifikationen):
 Other means of proving conformity with the essential requirements (standards/specifications used):

EN 300339 V1 1 1 (1998-06)

Anbringung des CE-Zeichens ab: 2008 / Affixing the EC conformity mark as from 2008

ROHDE & SCHWARZ GmbH & Co. KG
Mühldorfstr. 15, D-81671 München

München, den 6. Februar 2008
 Munich, 2008-02-06

 Zentrales Qualitätsmanagement MF-QZ / Radde
 Central Quality Management



4 Support center address

Should you have any questions regarding this Rohde & Schwarz instrument, please call our Support center hotline at Rohde & Schwarz Vertriebs-GmbH.

Our team will be happy to answer your questions and work with you to find a solution. The hotline is open Monday to Friday between 8 a.m. and 5 p.m.

Should you wish to contact us outside normal business hours, please leave a voice message or send us a fax or email. We will contact you as soon as possible.

If you would like to receive information on modifications and updates for a specific instrument, please send us a short email stating which instrument. We will ensure that you regularly receive the latest information.

Support center

Tel: +49 180 512 42 42

Fax: +49 89 41 29 137 77

Email: CustomerSupport@rohde-schwarz.com

5 Operating principle

Frontend

Starting from the antenna socket, the frequency in the signal path is limited to 8 GHz. Signal processing then takes place in three paths for three different frequency ranges. Signals from 9 kHz to 30 MHz are routed via a preamplifier directly to the A/D converter. Signals from 20 MHz to 3.5 GHz are taken to the IF section via a preselection and a preamplifier, or via an attenuator in the case of high signal levels. The preselection as well as the attenuator effectively protect the IF section against overloading. This is particularly important in this frequency range, where the maximum signal sum levels occur. Signals from 3.5 GHz to 8 GHz are taken to the IF section via a preamplifier. The three-stage IF section processes the signals from 20 MHz to 8 GHz for the subsequent A/D converter. To provide optimum instrument performance, only signals up to 7.5 GHz are processed in the subsequent stages. The uncontrolled 21.4 MHz IF can also be tapped ahead of the A/D converter via a BNC socket of the R&S®PR100 for further external processing.

Digital signal processing

After A/D conversion of the signal, the signal path is split up: In the first path, the IF spectrum is calculated by means of a digital downconverter (DDC), a digital bandpass filter and an FFT stage. The bandwidth of the bandpass filter can be selected between 10 kHz and 10 MHz. Before the IF spectrum is output on the display or via the LAN interface, results are postprocessed by means of the AVERAGE, MIN HOLD or MAX HOLD function as selected by the user. In the second path, the signal is processed for level measurement or demodulation. Here, too, the signal is taken via a DDC and a bandpass filter. To process the different signals with optimum signal-to-noise ratio, the receiver contains IF filters with demodulation bandwidths from 150 Hz to 500 kHz, which can be selected independently of the IF bandwidth. Prior to the level measurement, the absolute value of the level is determined and weighted by means of the AVERAGE, MAX PEAK, RMS or SAMPLE function, as selected by the user. The measured level is then output on the display or via the LAN interface. For the demodulation of analog signals, the complex baseband data is subjected to automatic gain control (AGC) or manual gain control (MGC) after the bandpass filter. It is then applied to the AM, FM, USB, LSB, ISB, PULSE or CW demodulation stage. The complex baseband data (I/Q data) of digital signals is directly output for further processing after the AGC/MGC stage.

The results obtained are available as digital data and can be output via the LAN interface as required for the particular task. Digital audio data are reconverted to analog signals for output via the loudspeaker.

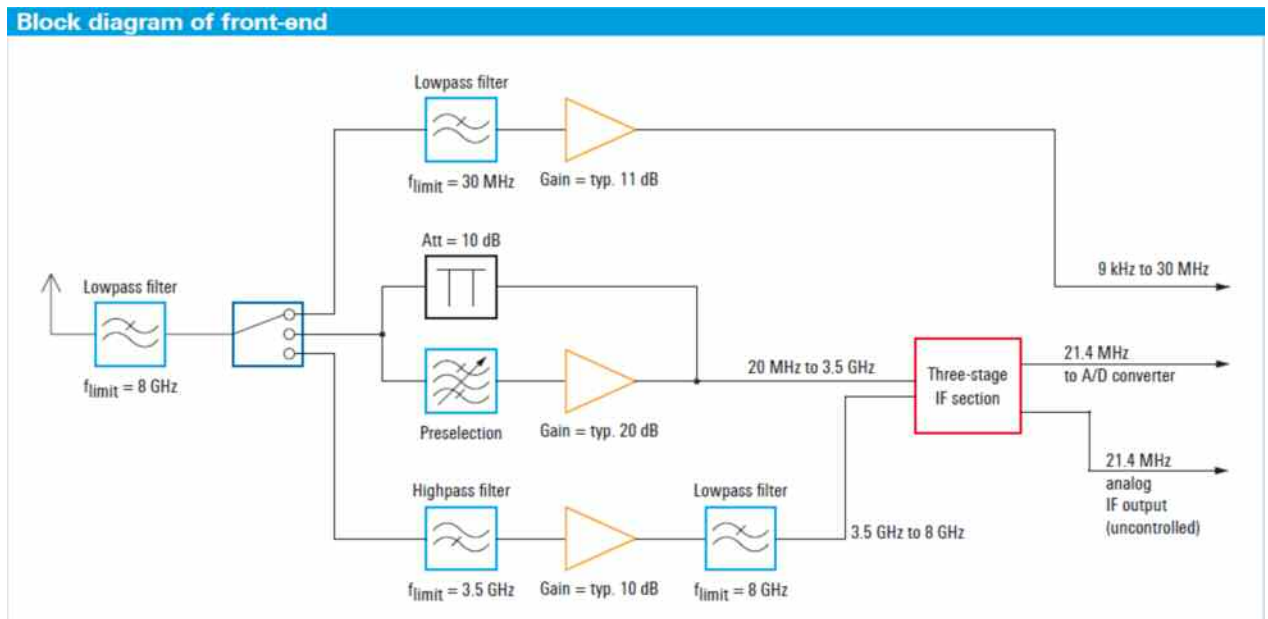

High receiver sensitivity, high signal resolution

The R&S® PR100 features an IF bandwidth of up to 10 MHz. This allows even very short signal pulses to be captured since the receiver displays the large bandwidth of 10 MHz in a single spectrum about the set center frequency without any scanning being required. The widest IF bandwidth of 10 MHz yields the widest spectral display; the narrowest IF bandwidth of 10 kHz yields maximum sensitivity. The IF spectrum is digitally calculated by means of a Fast Fourier Transform (FFT). The use of FFT computation at the IF offers a major advantage: The receiver sensitivity and signal resolution are clearly superior to those of a conventional analog receiver at the same spectral display width.

IF spectrum

FFT calculation of the IF spectrum is performed in a number of steps. These are described below in simplified form for an IF bandwidth of 10 kHz ($B_{WIF\text{ spectrum}} = 10\text{ kHz}$), which yields maximum sensitivity. Due to the finite edge steepness of the IF filter, the sampling rate f_s must be larger than the selected IF bandwidth $B_{WIF\text{ spectrum}}$. The quotient of the sampling rate and the IF bandwidth is thus a value >1 and is a measure of the edge steepness of the IF filter. This relationship is expressed by the following two formulas:

$$\frac{f_s}{B_{WIF\text{ spectrum}}} = \text{const}$$

or

$$f_s = B_{WIF\text{ spectrum}} * \text{const}$$

The value of the constant is dependent on the selected IF bandwidth, i.e. it may vary as a function of the IF bandwidth. For an IF bandwidth of $B_{WIF\text{ spectrum}} = 10\text{ kHz}$, the constant has a value of 1.28. To display a 10 kHz IF spectrum, therefore, a sampling rate of $f_s = 12.8\text{ kHz}$ is required.

Block diagram of digital signal processing

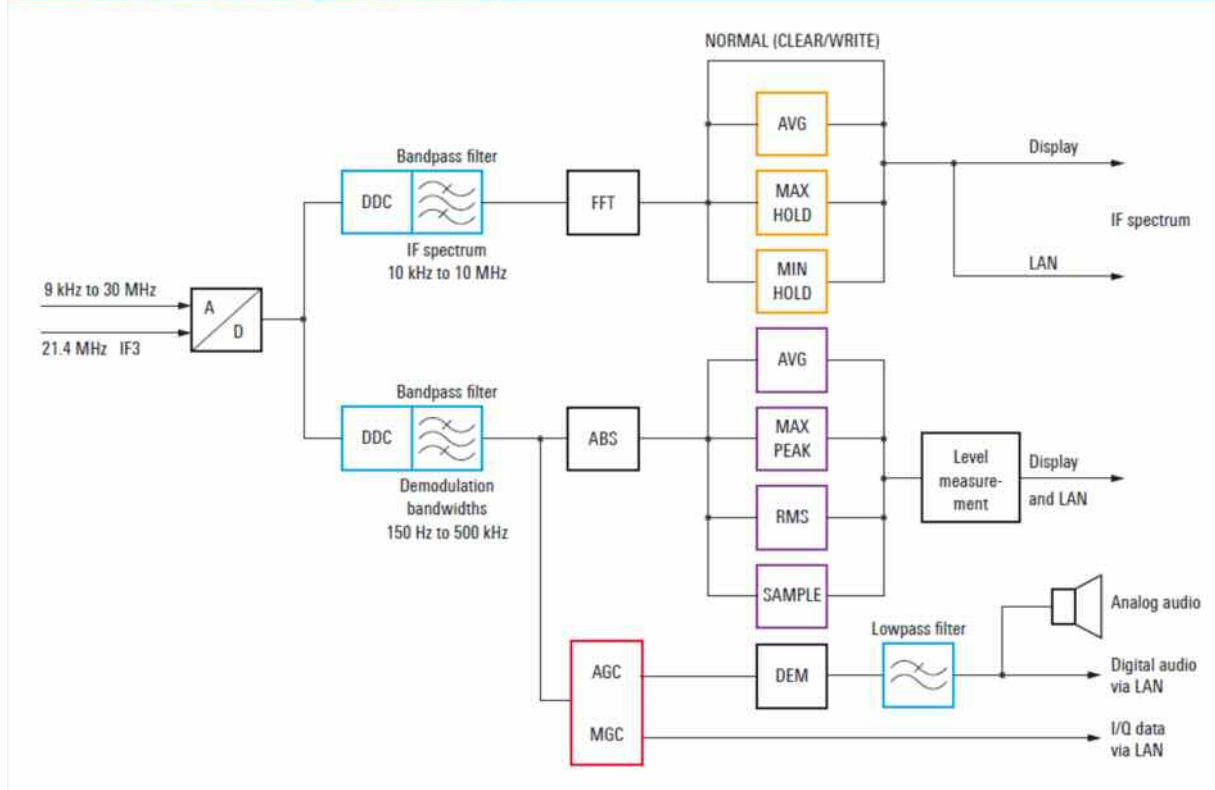

The R&S®PR100 uses an FFT length N of 2048 points to generate the IF spectrum. To calculate these points, the 12.8 kHz sampling band in the above example is divided into 2048 equidistant frequency slices, which are also referred to as “bins” (see figure “Signal processing for IF spectrum”). The bandwidth BW_{bin} of the frequency slices is obtained as follows:

$$BW_{bin} = \frac{f_s}{2048} = \frac{12.8kHz}{2048} = 6.25Hz$$

This means that in the above example only the calculated bandwidth of 6.25 Hz for each bin has to be taken into account as the noise bandwidth in the calculation of the displayed average noise level (DANL) in accordance with the formula below (the effect of the window function (Blackman window) of the FFT is not considered here for simplicity's sake):

$$DANL = -174dBm + NF + 10 * \log(BW_{bin} / Hz)$$

The quantity NF represents the overall noise figure of the receiver. The above example shows that, due to the use of the FFT, the actual resolution bandwidth (RBW) to be taken into account in DANL calculation is clearly smaller (i.e. BW_{bin}) than would be expected for the wide display range of 10 kHz. Another advantage of the high spectral resolution used in the FFT calculation is that signals located close together (e.g. f_1 , f_2 , f_3) can be captured and represented in the IF spectrum as discrete signals (see figure “Signal display in IF spectrum”). If, on an analog receiver, a resolution bandwidth equal to the set IF bandwidth were selected ($RBW = BW_{IF}$ spectrum), a sum signal f_{sum} would be displayed instead of the three discrete signals f_1 , f_2 and f_3 .

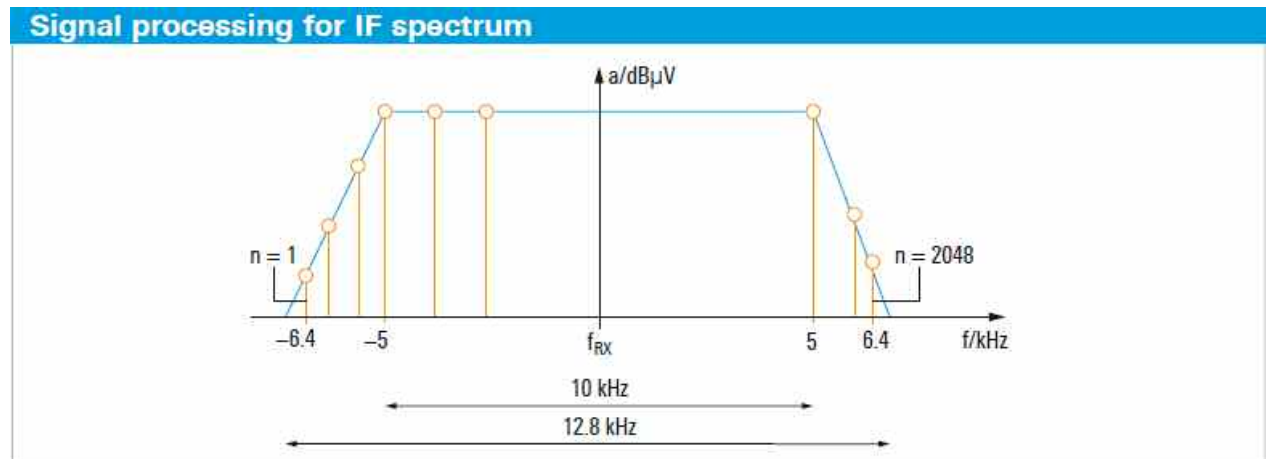

Actual sampling bandwidth compared with selected IF bandwidth

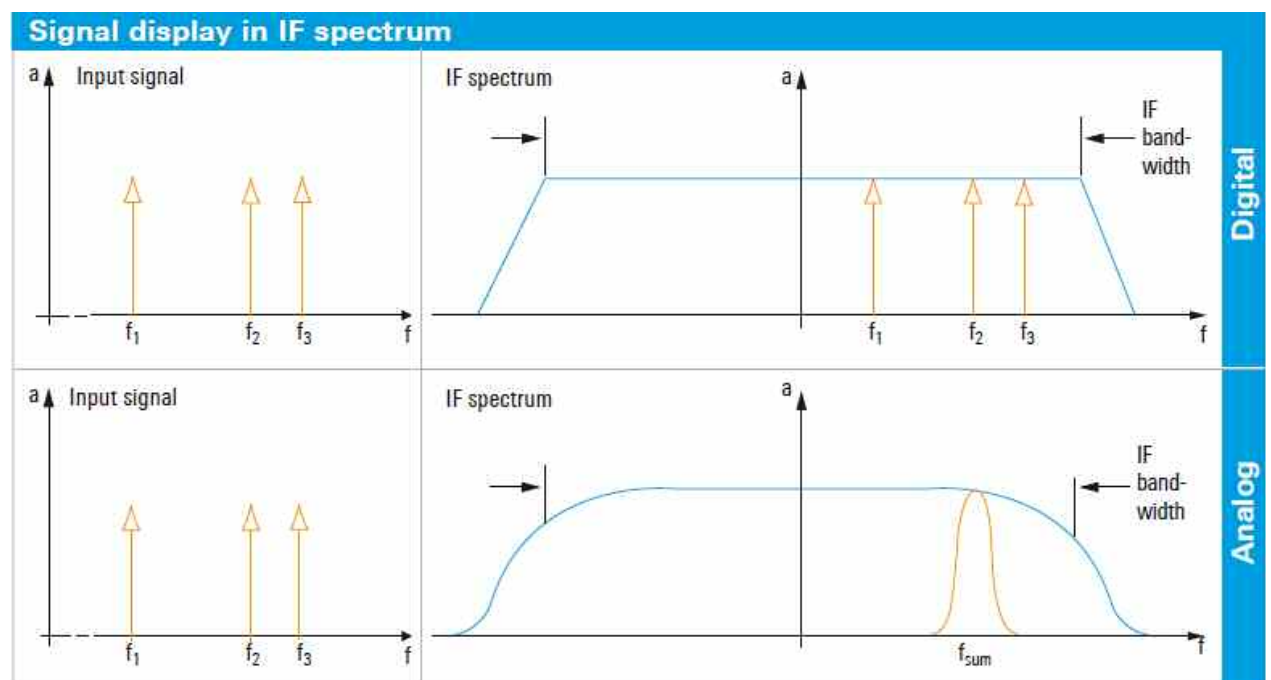

Signal resolution in IF spectrum with digital and analog receiver concept

Panorama scan

The receiver's maximum FFT bandwidth of 10 MHz makes it possible to perform extremely fast scans across a wide frequency range (panorama scan). For this purpose, frequency windows of max. 10 MHz width are linked in succession, and thus the complete, predefined scan range is traversed (see figure "Signal processing in panorama scan mode"). Same as with the IF spectrum, an FFT is used to process the broad window with a finer resolution. The width of the frequency window and the FFT length (number of FFT points) are variable and are selected by the receiver. In the panorama scan mode, the user can select among 12 resolution bandwidths from 125 Hz to 100 kHz. The resolution bandwidth corresponds to the width of the frequency slices (bin width) mentioned under "IF spectrum" above. Based on the selected bin width and start and stop frequency, the R&S®PR100 automatically determines the required FFT length and the width of the frequency window for each scan step. The receiver selects these internal parameters so that the optimum scan speed is achieved for each resolution bandwidth (see figure "Resolution in panorama scan mode").

Signal processing in panorama scan mode

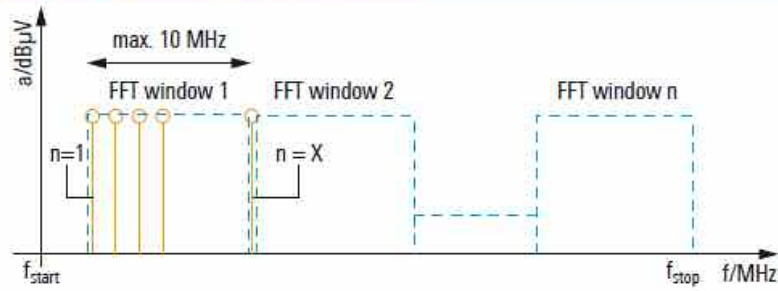

Basic sequence of steps in fast panorama scan mode

Resolution in panorama scan mode

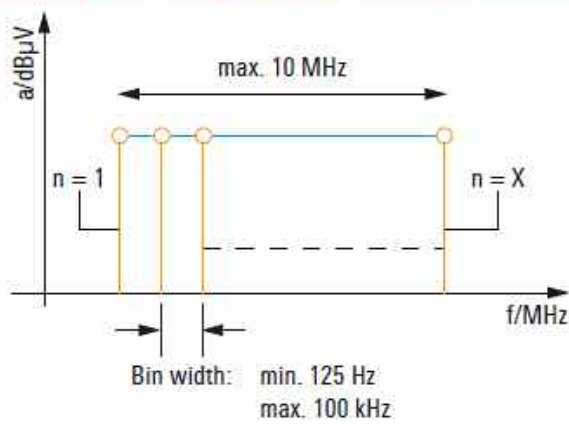

Selection of resolution for panorama scan by varying the bin width.

Bin width and channel spacing

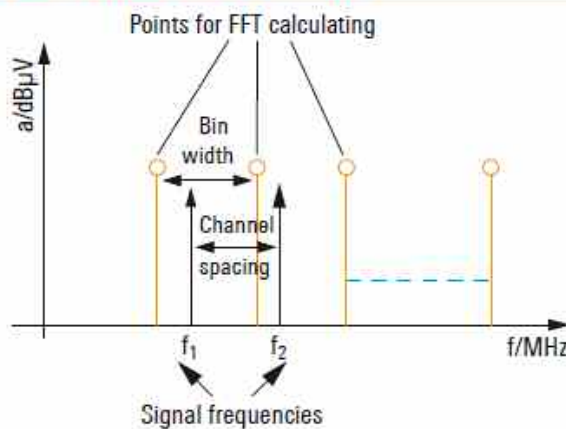

Selection of 12.5 kHz bin width to capture a radio service using 12.5 kHz channel spacing

6 Set-up

6.1 Front view



| | |
|-----------------------------------|-----------------------|
| 1 Aux. / Ext Ref. / IF interfaces | 7 On/off switch |
| 2 LAN and USB interface | 8 Input keys |
| 3 Softkeys | 9 Unit keys |
| 4 Function keys | 10 Cursor keys |
| 5 Function keys | 11 Key lock |
| 6 (Alpha)-numeric keypad | 12 Rotary knob |
| | 13 Memory access keys |
| | 14 SD Card slot |

6.2 Top view

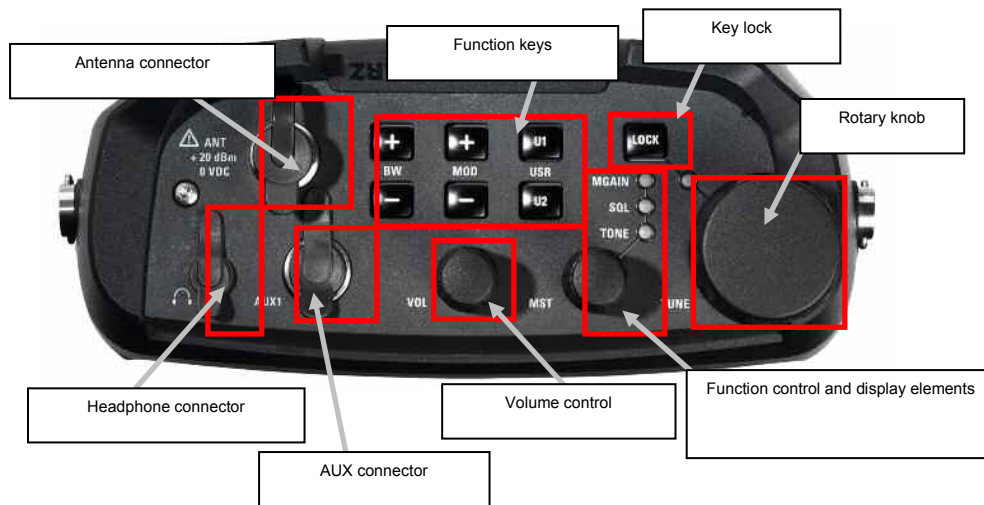

The following section describes how to set up the instrument and how to connect external devices including the charger. It then describes typical uses by means of screenshots.

6.3 Unpacking the instrument

The R&S PR100 is supplied in form-fit packaging consisting of an upper and lower shell. The two shells are held together by a sleeve which encloses the packaging.

The packaging contains all accompanying accessories. To unpack the instrument, remove the sleeve. Remove the R&S PR100 and the accessories. Remove the protective film from the screen.

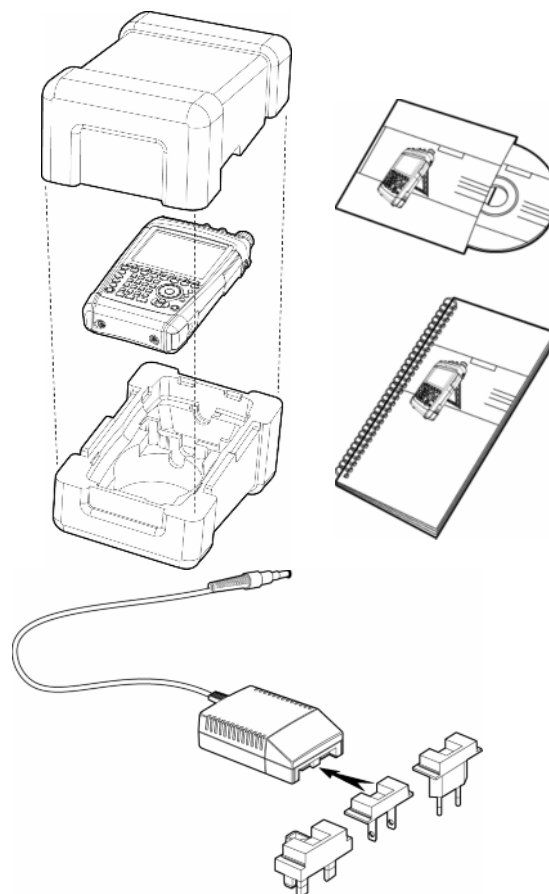

6.4 Setting up the instrument

The R&S PR100 portable monitoring receiver is designed for stationary, in-vehicle and in particular for portable use.

Depending on operating conditions, the device can be set up perfectly for both operation and the viewing angle of the display.

When used as a desktop instrument, the R&S PR100 can either lie flat or stand up using the folding stand on the back.

For portable use, it is best to attach the receiver to the chest carrying strap. All the control buttons are then easily accessible and the display can be easily read.

Depending on operating conditions, the device can be set up perfectly for both operation and the viewing angle of the display.

When used as a desktop instrument, the R&S PR100 can either lie flat or stand up using the folding stand on the back.



6.5 Inserting the battery

The R&S PR100 is fitted with a lithium ion battery.

The HA-Z206 battery pack has a charging capacity of 6.75 Ah.

The battery is inserted into the bottom right of the instrument.

The cover must first be pulled downwards to unlock it and then folded upwards to open it.

The battery is NOT fitted in the R&S PR100 on delivery and must therefore be fitted before the device can be used for the first time.

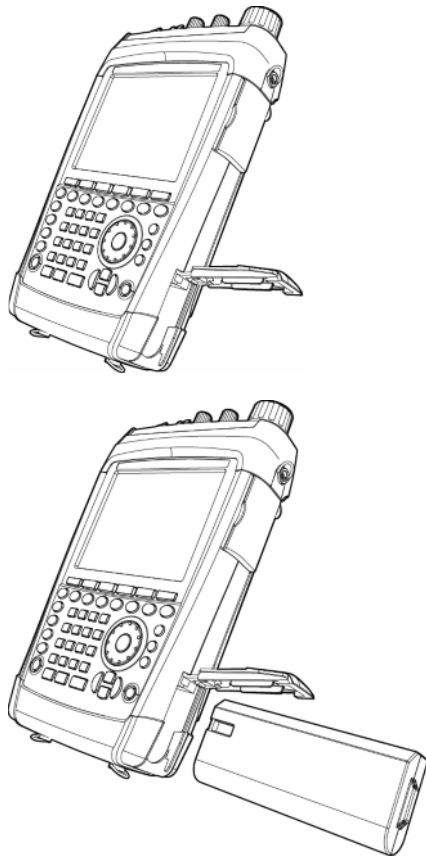

6.6 Connecting to the power supply

The R&S PR100 can be powered using the mains power adaptor or the internal battery supplied. When fully charged, the built-in lithium ion battery permits approx. 3.5 hours of operation. When the R&S PR100 is delivered, the battery may be completely discharged. Should you wish to use it without a mains power connection you will therefore need to charge it. Charging time is approx. 3.5 hours with the device switched off. During operation using mains power, the R&S PR100 simultaneously charges the internal battery. Insert the power adaptor plug into the POWER ADAPTOR socket on the left-hand side of the device until it clicks into place. Then connect the adaptor to the mains power socket.

The adapter voltage range is 100 V to 240 V AC / 50 Hz to 60 Hz.

The PR100's DC supply range is +15 V DC +/-10%, max. 2 A

Caution!

The R&S HA-Z201 power adaptor supplied should only be used to operate the device or to charge the battery using mains power.

Ensure that the mains supply voltage is compatible with the voltage specified on the adaptor before use. Attach the appropriate connector before inserting the adaptor into the AC power outlet.

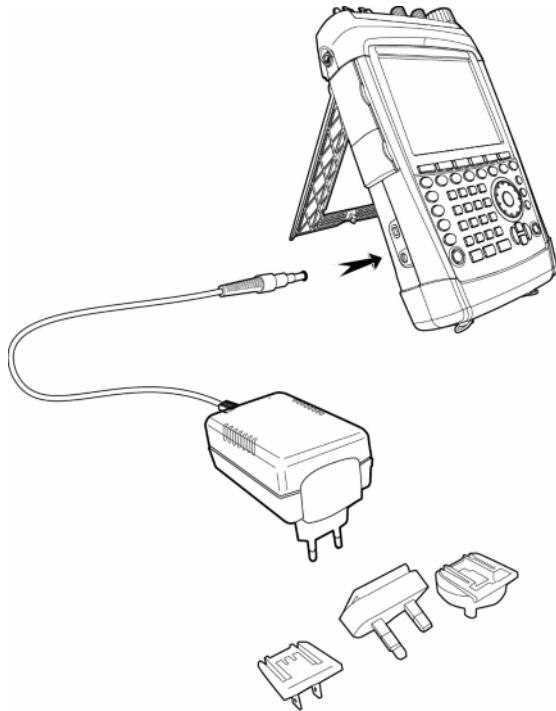

6.7 Charging the Battery

The R&S PR100 is equipped with a lithium ion battery. The battery permits approximately 3.5 hours' operation at room temperature when it is fully charged.

Caution!

On delivery, the R&S PR100's battery is not fully charged. The battery therefore needs to be charged before the device can be used for the first time.

If the unit is stored for an extended period, self-discharge will reduce the battery's charge. The battery should therefore be charged before use if it is intended to be the sole power source for an extended period.

The charge status of the battery pack is shown on the instrument's display.

The battery can either be charged directly in the instrument by using the supplied adaptor or with the optional external R&S HA-Z203 battery charger. Charging takes approx. 7 hours with the device switched on.

For faster charging, switch off the instrument during charging. Charging takes approx. 3.5 hours with the device switched off or by using the external charging unit.

Insert the adaptor plug into the POWER ADAPTER socket on the left side of the instrument until it locks into place. Then connect the adaptor to the mains power supply.

The adaptor voltage range is 100 V to 240 V / 50 Hz to 60 Hz.

The device's DC supply range is +15 V DC +/-10%, max. 2 A

To charge the battery externally, place it in the external R&S HA-Z203 battery charger and charge it using the plug-in power adaptor.

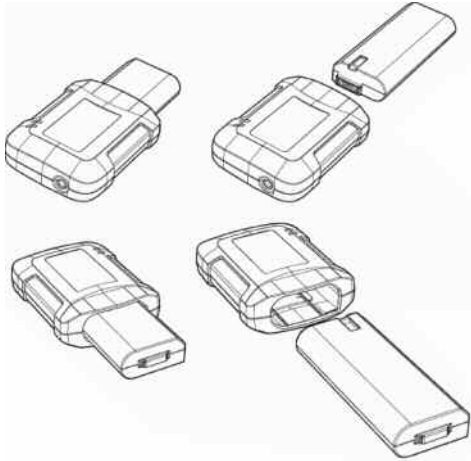

The plug-in power adaptor is the same R&S HA-Z201 adaptor used for the receiver itself.

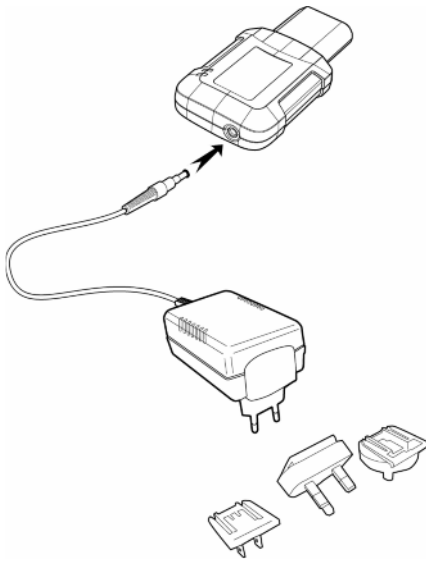

6.8 Switching on the monitoring receiver



To switch on the R&S PR100, press the grey button at the bottom left of the front panel.

When the R&S PR100 is switched on, the settings in use when it was last switched off are loaded.

Should you wish to start the R&S PR100 with factory settings, the LOCK key should be pressed and held for approx. 5 seconds when you switch the unit on.

6.9 Ambient and operating conditions

The R&S® PR100 will operate reliably in the following ambient and operating conditions:

Max. humidity 95 %

Rated operating altitude max. 4600 m above sea level

Transport altitude max. 12000 m above sea level

Excess voltage category 2

Pollution level 2

6.10 Preventive maintenance

Any dirt should be removed from the R&S® PR100 with a soft damp cloth and a mild detergent.

In case of a fault the following safety-critical parts should only be replaced with original Rohde & Schwarz spare parts:

Power adaptor 1309.6100.00

Battery charger 1309.6123.00

Six-cell battery pack 1309.6149.00

6.11 Monitoring receiver connectors

The R&S PR100 has the following connectors:

RF input

Connect the RF input to the antenna using a cable with an N connector. Make sure that the input is not overloaded.

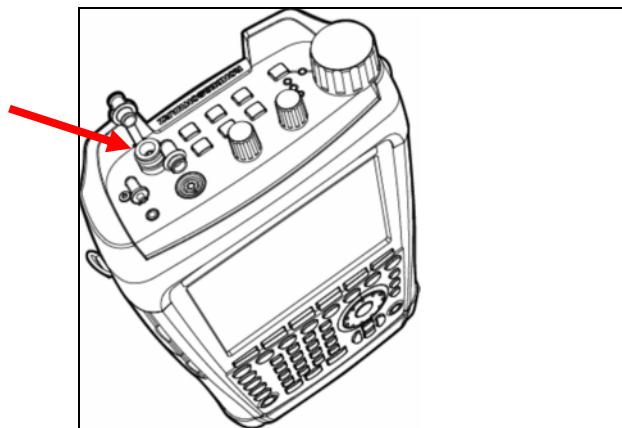

Caution!



The maximum permissible continuous power at the HF input is +20 dBm (100 mW).

The maximum permissible DC voltage at the HF input is 0 VDC.

Headphone connector

A 3.5 mm stereo socket is provided for headphones. The connector's internal resistance is approx. 100 Ω.

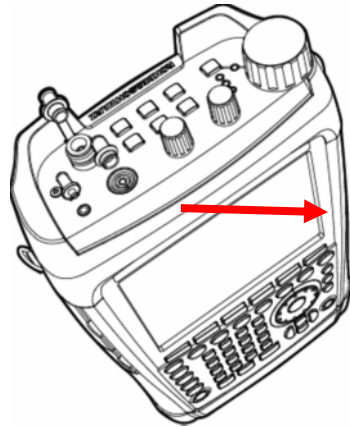
**AUX1 IN/OUT (at top)**

External control signals can, for example, be fed to the receiver via the AUX1 IN/OUT connector.

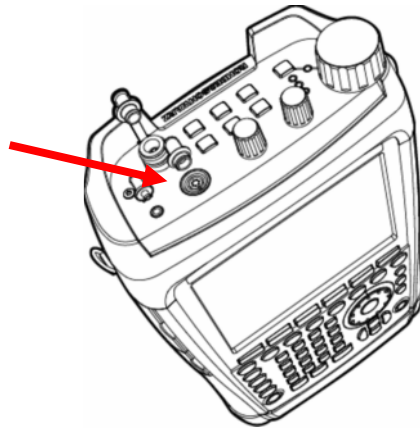
**AUX2 IN/OUT**

Control signals for measurements triggered externally can be fed in via the AUX2 input/output connector (e.g. for coverage measurement applications).

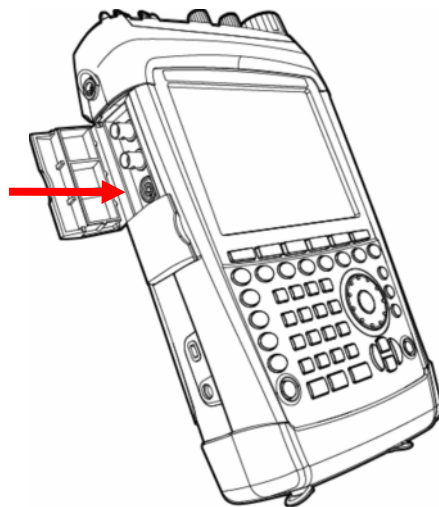
**External reference input**

A 10 MHz reference signal for frequency synchronization is received via the EXT REF BNC socket. The level for the reference signal must be greater than 0 dBm.

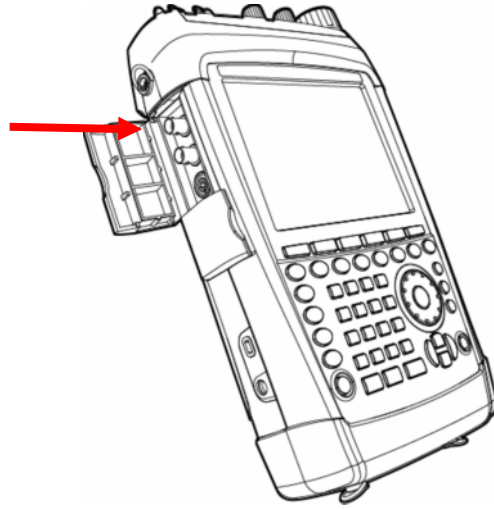
**IF output**

The unregulated 21.4 MHz IF signal is transmitted via the IF OUT BNC socket.

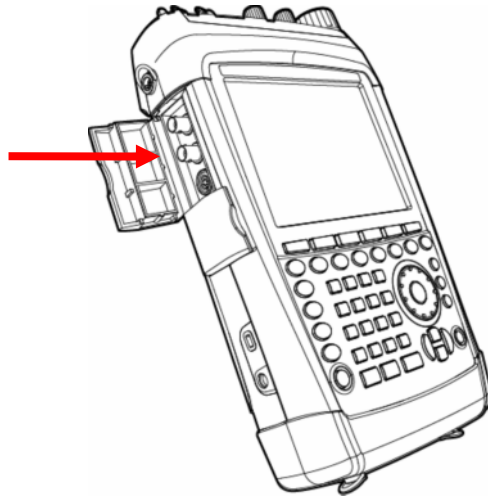
**USB interface**

The instrument is equipped with a USB1.1 interface for reading data stored on the SD card.

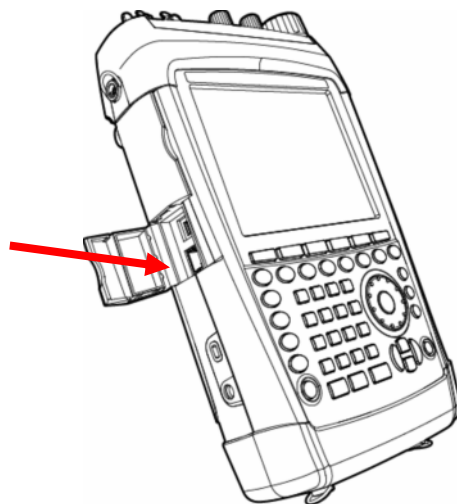

LAN interface

The instrument is equipped with a 10/100 Base T LAN interface for rapidly reading data stored on the SD card or for operating the receiver remotely.

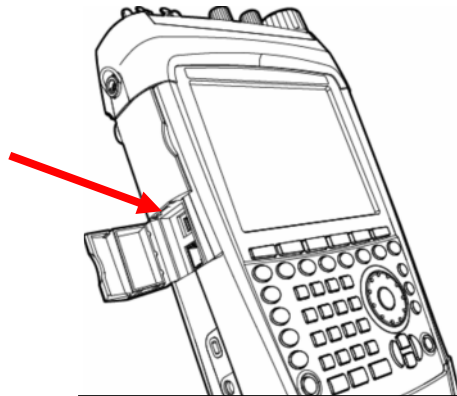

In order to comply with electro-magnetic compatibility guidelines (R&TTE), only LAN cables shorter than 3 m may be used (see recommended accessories).

Mechanical hardware protection

Mechanical hardware protection for the R&S PR100 at a workstation can be provided by installing a Kensington lock in the receiver's housing.

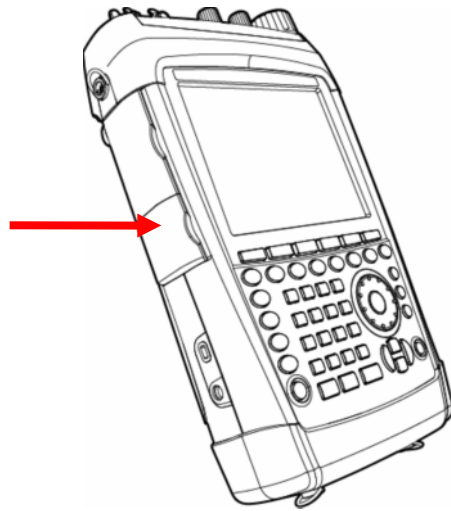
**SD memory card**

The SD card for storing measurements or user settings is inserted into the upper right side of the R&S PR100.



Screen settings

The R&S PR100 screen is a 6.5" VGA display. The brightness of the backlight can be adjusted between 0% and 100%.

To obtain a balance between battery operating time and screen display quality, set backlighting to the minimum level necessary.

Setting the backlight and color scheme

- Press the CONF key.
- Press the GENERAL softkey.



- Adjust the backlight strength for the screen
- Use the rotary knob or cursor keys to select the setting you want and confirm by pressing ENTER.

Setting the display color

- Press the CONF key.
- Press the GENERAL softkey.

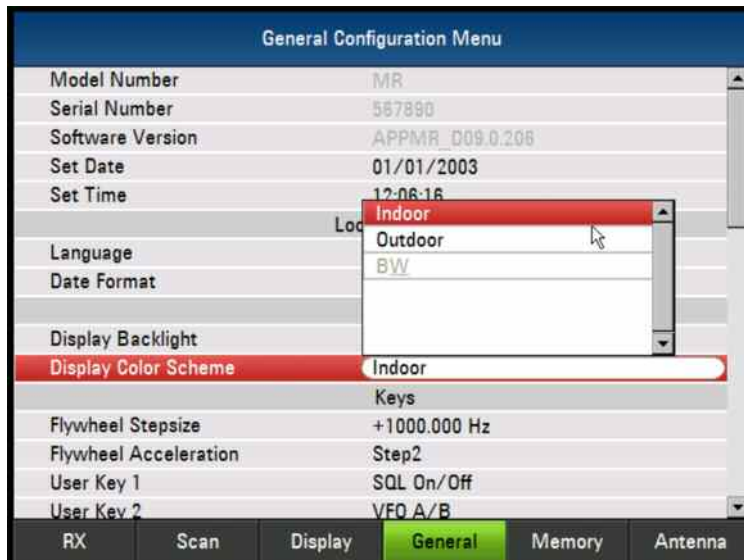

Adjust the screen colors.

Use the rotary knob or the cursor keys to select the setting you want and confirm by pressing ENTER.

Country-specific settings

The R&S PR100 supports multiple languages and can display text in the language of your choice. Softkey lettering is always in English. The default setting (factory setting) is also English.

Operation

- Press the CONF key.
- Press the GENERAL softkey.

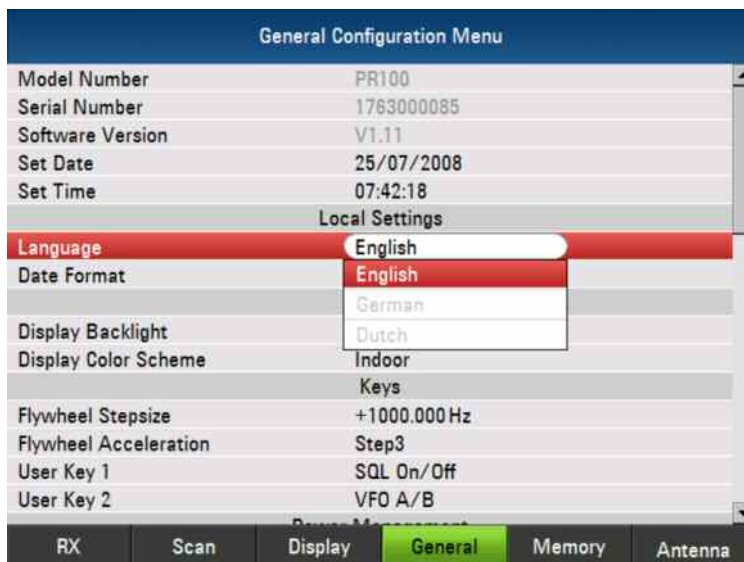

Set the receiver's menu language

Use the rotary knob or the cursor keys to select the setting you want and confirm by pressing ENTER.

Setting the date and time

The R&S PR100 has an internal clock which can, for example, provide stored data records with a date and time stamp. The date and time can be reset by the user.

Setting the date

- Press the CONF key.
- Press the GENERAL softkey.



Set the receiver's date.

Enter the date using the numeric keypad and then confirm by pressing ENTER.

- Press the CONF key.
- Press the GENERAL softkey.



Set the date format

Use the rotary knob or the cursor keys to select the setting you want and confirm by pressing ENTER.

Setting the time

- Press the CONF key.
- Press the GENERAL softkey.

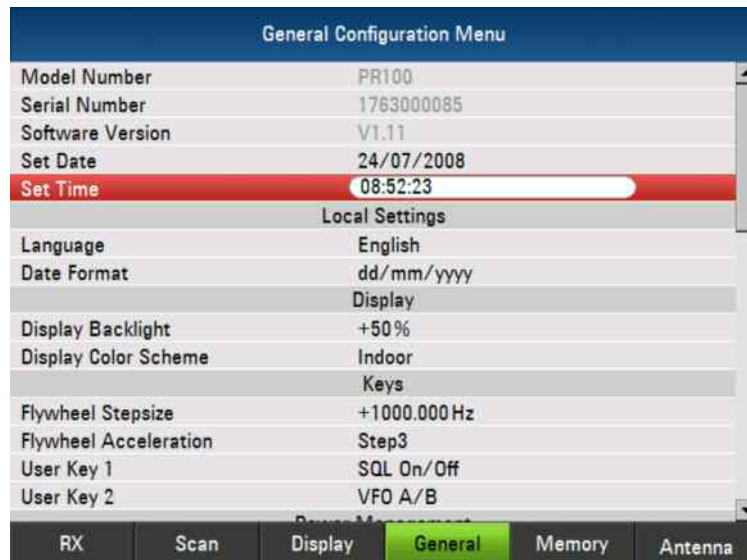

Set the time

Enter the date using the numeric keypad and confirm it by pressing ENTER.

Once the minutes have been entered, the R&S PR100 checks whether the time entered is valid. If the time is not valid, the R&S PR100 will set the next valid time.

6.12 Software update

To operate the R&S PR100 with the latest features, it is recommended to install the newest firmware version.

A new firmware version can be downloaded via the R&S website. In order to install the firmware, it must first be copied onto an SD Card, e.g. HA-Z231, order #1309.6217.00. You can also follow the link on the CD supplied with the instrument.

Copy the following files from your PC to the root directory of the SD-card:

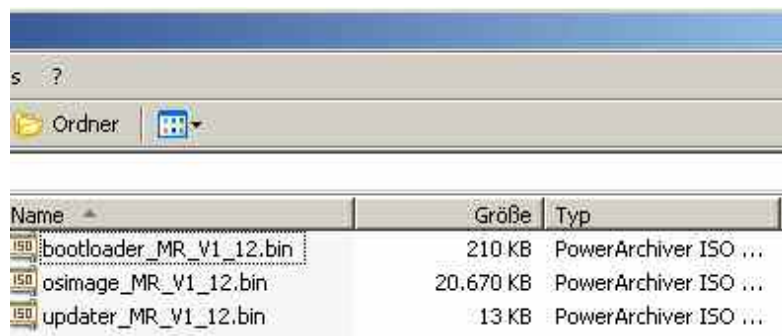

The version number of the files varies with the stand of the firmware.

Note!



Please make sure that only one file of each type is present on the SD card. The update mechanism will reject the card if it detects two versions of a file type and abort the update later on.

- Switch the instrument of
- Insert the SD card into the SD card slot on the right side of the PR100
- Connect a mains-adaptor (otherwise the PR100 will refuse to start the firmware update)
- During pressing the buttons [LOCK] and [8] at the same time, switch on the PR100. Keep both buttons [LOCK] and [8] pressed for about 5 seconds after switching on the PR100.
- Continue following the instructions on the PR100's screen.

Caution!

Risk of damage to the instrument

DURING FIRMWARE UPGRADE, DO NOT TURN OFF THE PR100!

- In order to make the update effective, turn off the PR100 and turn it on again.
- During the first start up after updating the firmware, press the buttons [LOCK] and [F6] for about 5 seconds. This will format the PR100's file system to start from a defined basis after the update.
- Formating process takes about 3 minutes.
- Your PR100 is now updated successfully.

6.12.1 Option code activation

- Press the CONF key.
- Press the GENERAL softkey.



Enter the option code

Confirm the option code by pressing the ENTER key.

If the correct code is entered the option will be activated and can be used.

7 Configuration Menus

7.1 RX Configuration Menu

All menu – lines can be selected and activate by using the rotating wheel or using the arrow – keys and the ENTER – button.

7.1.1 General

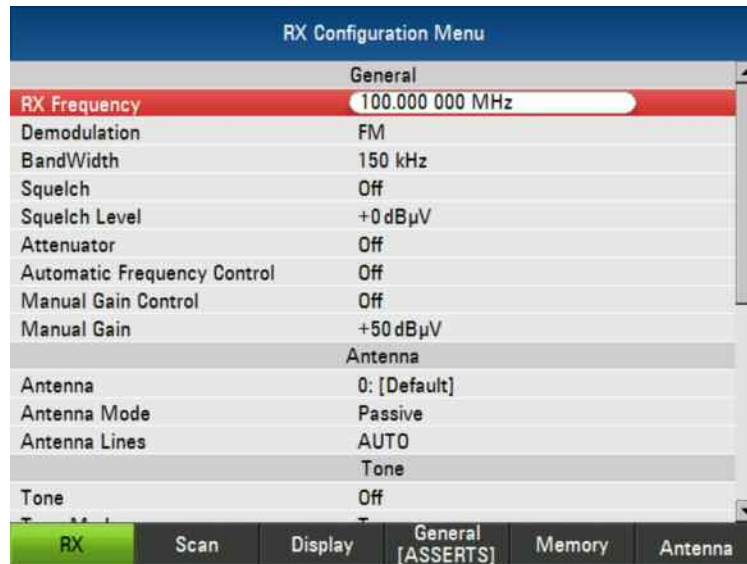

RX Frequency:

By selecting the RX Frequency it is possible to key in the RX Frequency. Adjustable from 9 kHz to 7.5 GHz.

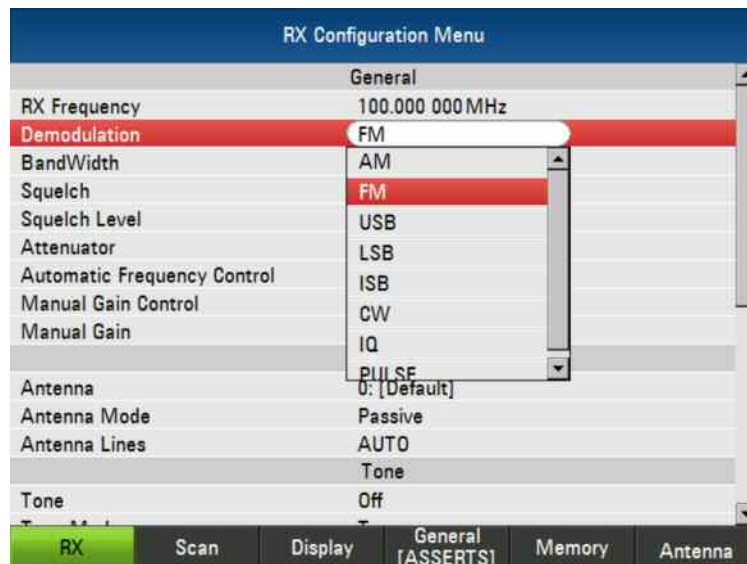

Demodulation:

Selects the demodulation mode.

Available modes: AM, FM, USB, LSB, ISB, CW, IQ, PULSE

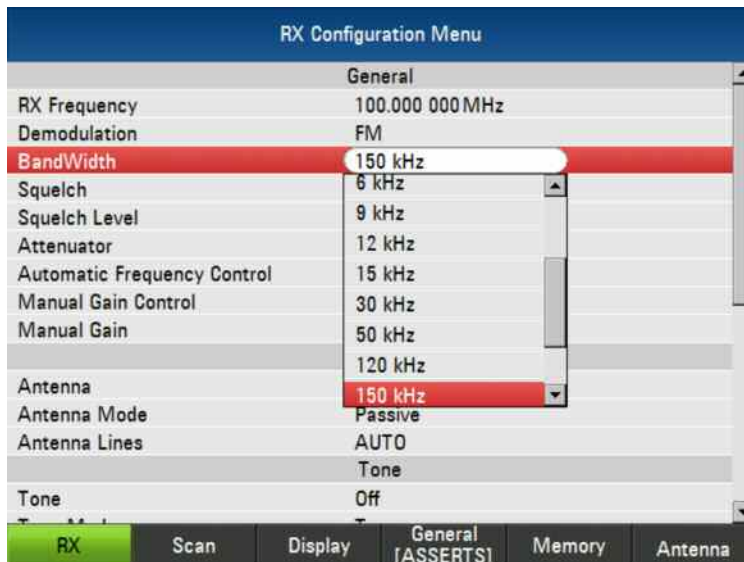

Bandwidth:

Selects the demodulation bandwidth

Available Bandwidths: 150Hz, 300Hz, 600Hz, 1.5KHz, 2.4KHz, 6KHz, 9KHz, 12KHz, 15KHz, 30KHz, 50KHz, 120KHz, 150KHz, 250KHz, 300KHz, 500KHz

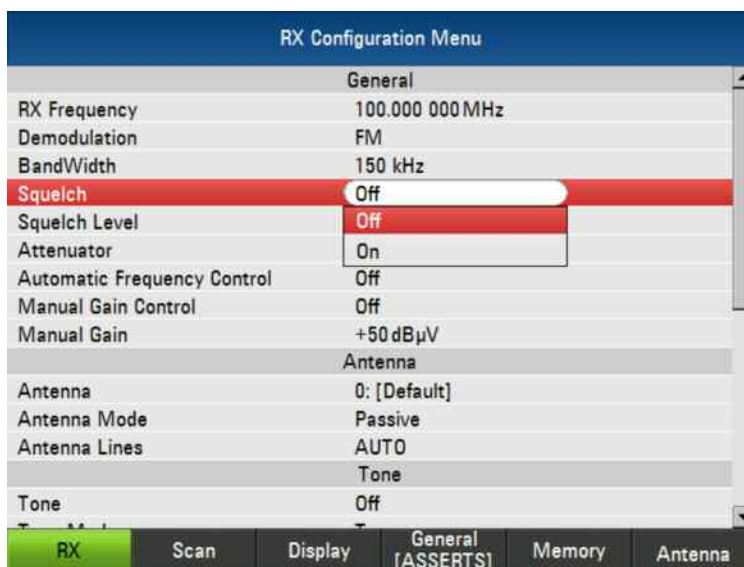

Squelch:

Select this menu-item to set SQUELCH ON of OFF

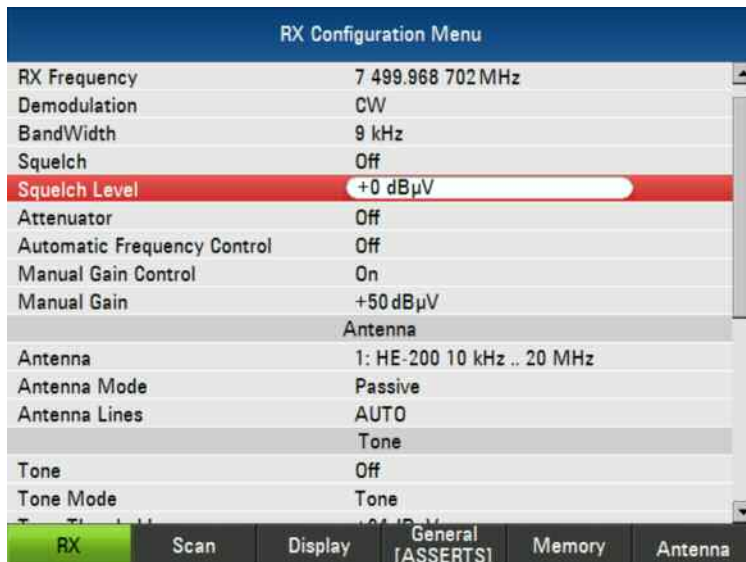

Squelch Level:

Select to setting up the squelch level. Adjustable from -30dB μ V to +110dB μ V.

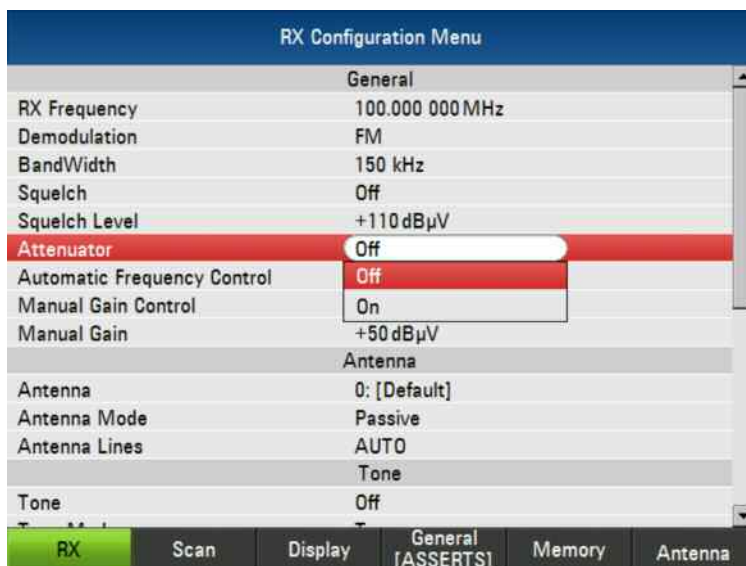

Attenuator:

Use this menu-item to switch the Attenuator ON or OFF.

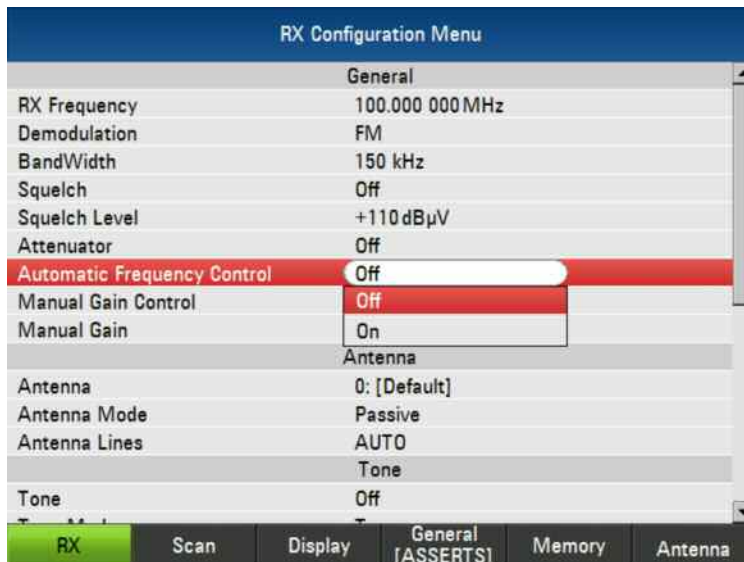

Automatic Frequency Control:

This menu-item allows you to activate or deactivate automatic frequency correction.

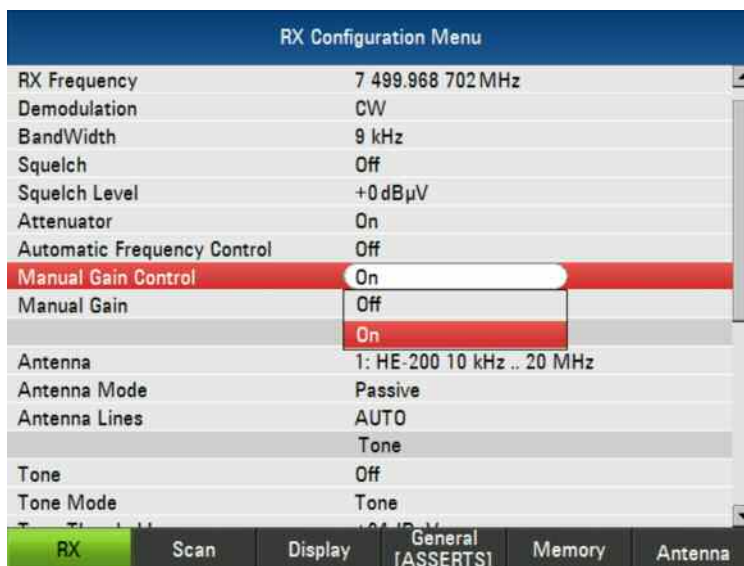

Manual Gain Control:

Switches the Manual Gain Control ON or OFF

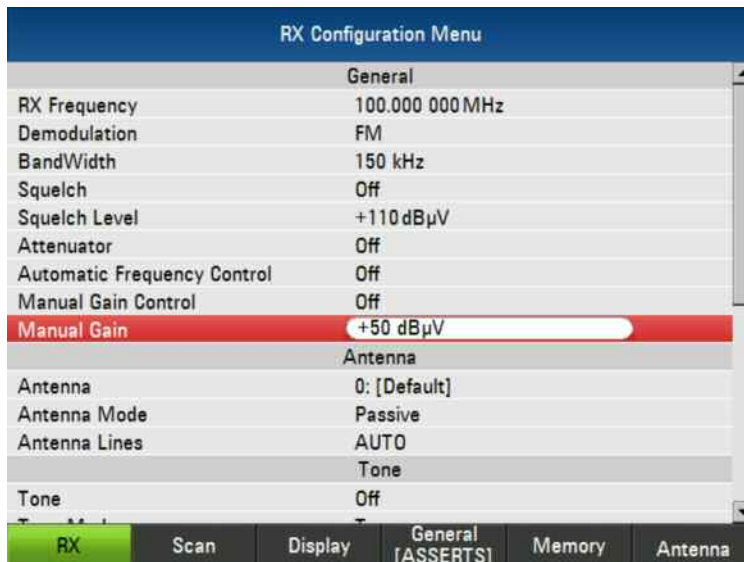

Manual Gain:

Setting up the Gain for the manual gain control. Adjustable from -30dBµV to +110dBµV. Only active, if manual gain control is ON

7.1.2 Antenna (only with option Field Strength Measurement)

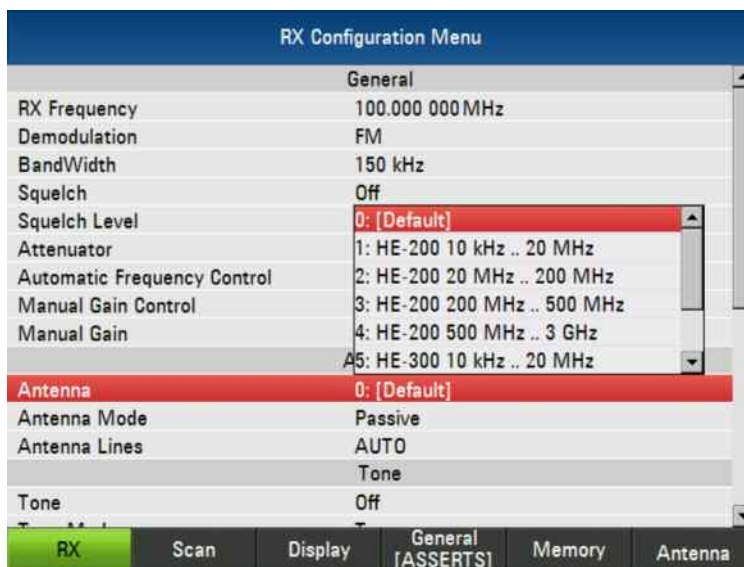

Antenna:

This menu-item allows you to select the connected Antenna.

Available Antennas by default:

HE-200 10kHz .. 20MHz,

HE-200 20 MHz .. 200 MHz,

HE-200 200 MHz .. 500 MHz,

HE-200 500 MHz .. 3 GHz,

HE-300 10kHz .. 20MHz,

HE-300 20 MHz .. 200 MHz,

HE-300 200 MHz .. 500 MHz,

HE-300 500 MHz .. 7 GHz

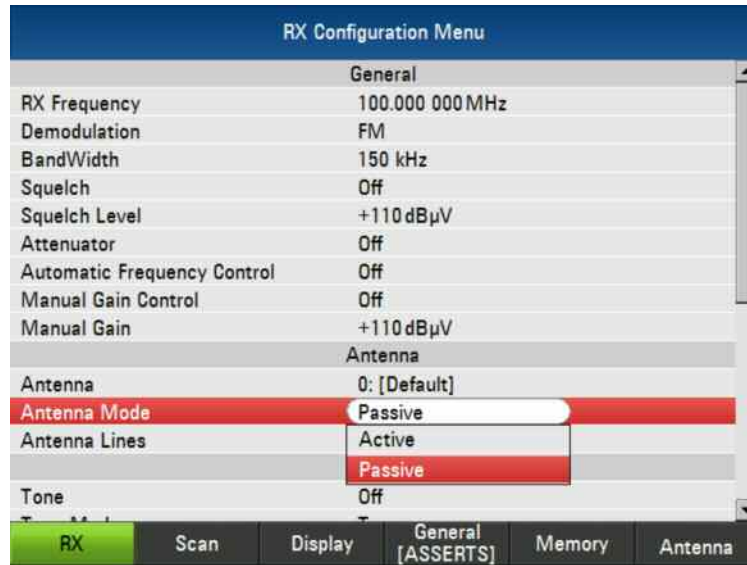

Antenna Mode:

This menu-item allows you to select the mode of the antenna.

Available Modes: Active, Passive.

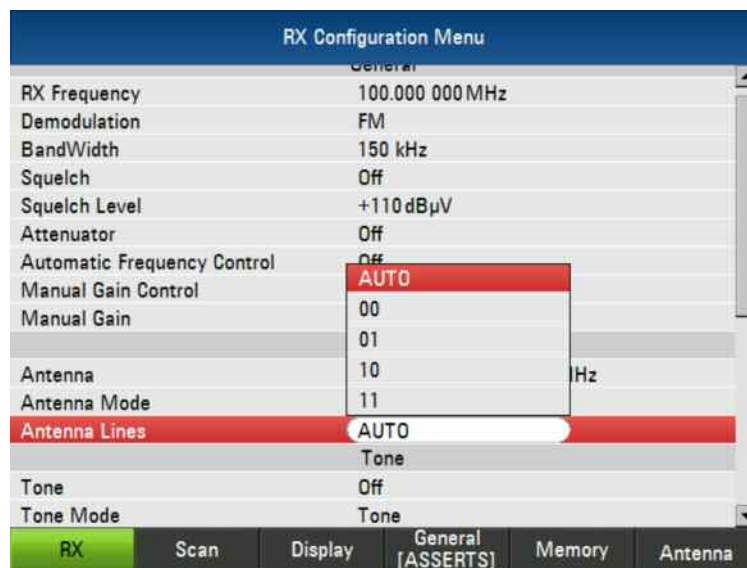

Antenna Lines:

Activate the ANT0 or ANT1 – Lines at AUX1 (Top connector)

AUTO --> Auto-Setting for selected antennas

00 --> ANT0 and ANT1 off

01 --> ANT0 on

10 --> ANT1 on

11 --> ANT0 and ANT1 on

7.1.3 Tone

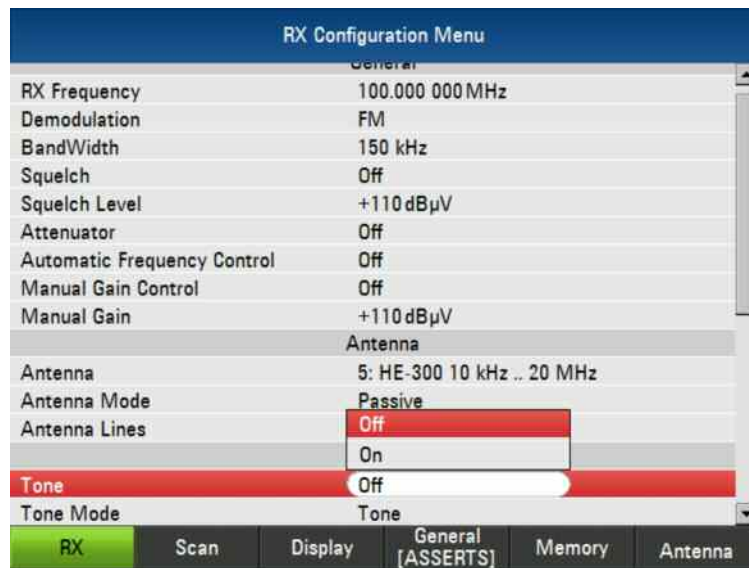

Tone:

Select this menu-item to switch the tone ON or OFF the.

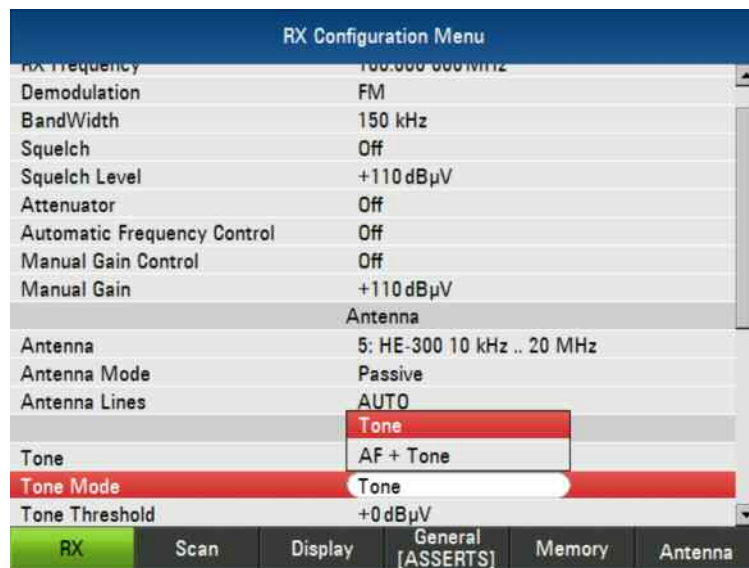

Tone Mode:

Select this menu-item to select

Available Modes: Tone, AF + Tone

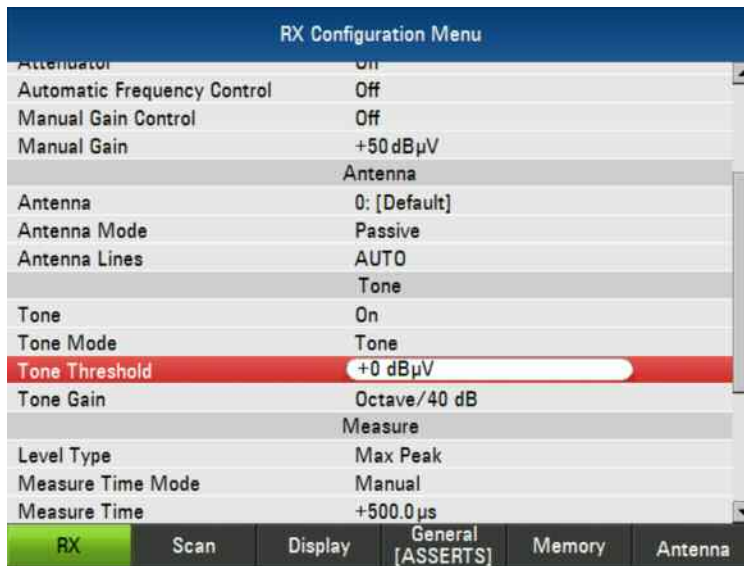

Tone Threshold:

Setting up the threshold - level for the Tone. Adjustable from -14 dB μ V to +94 dB μ V.

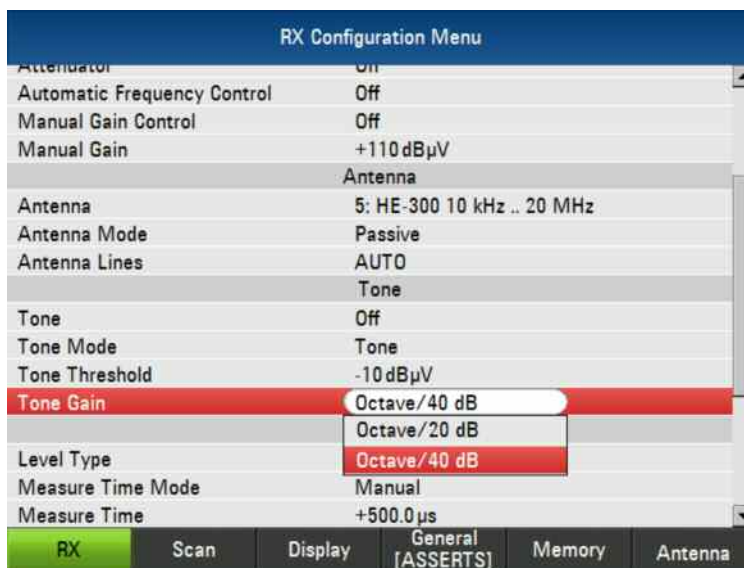

Tone Gain:

Select the Octave/Gain for the Tone.

Available Modes: Octave/20 dB, Octave/40 dB

7.1.4 Measure

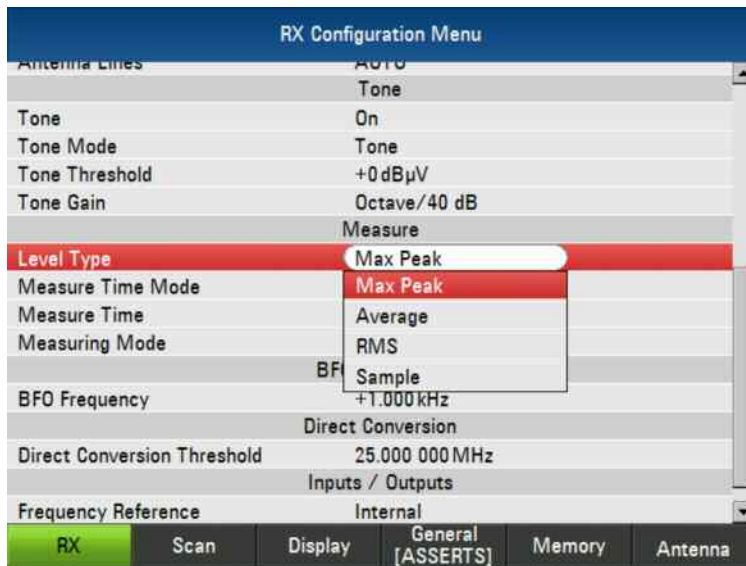

Level Type:

Selects the level measurement mode.

Available modes: Max Peak, Average, RMS, Sample

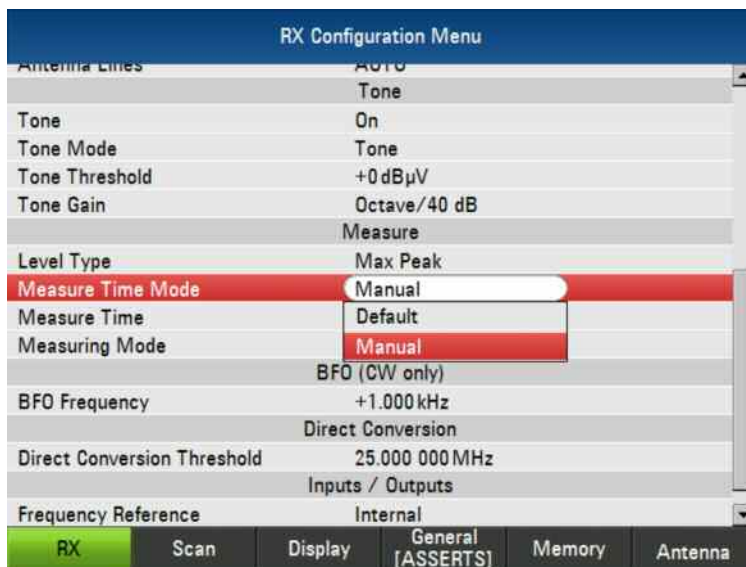

Measure Time Mode:

Select the mode for the measure time.

Available modes: Default (Auto), Manual

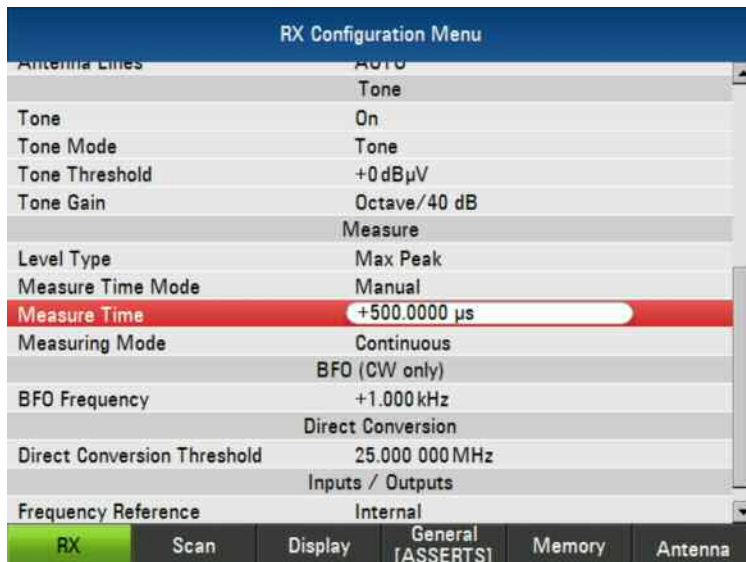

Measure Time:

Setting up the measure time. Adjustable from +500.000 μ s to +900 s.

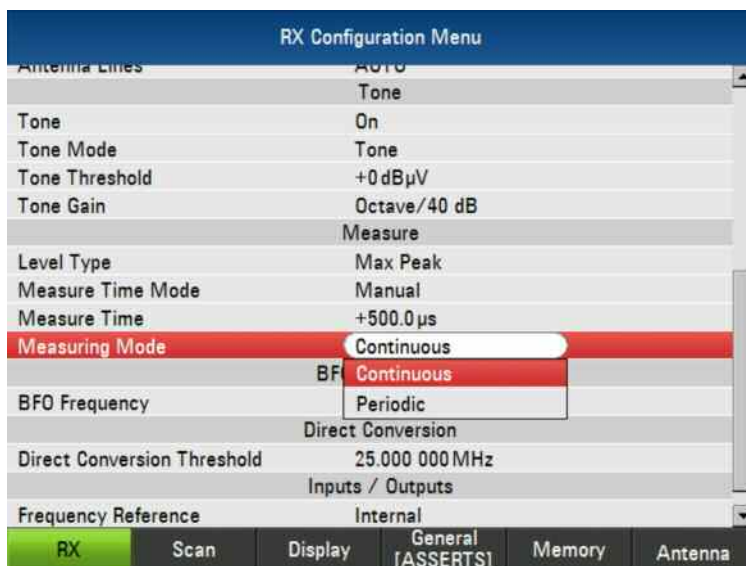

Measuring Mode:

Setting up the measuring mode.

Available modes: Continuous, Periodic

7.1.5 BFO (CW only)

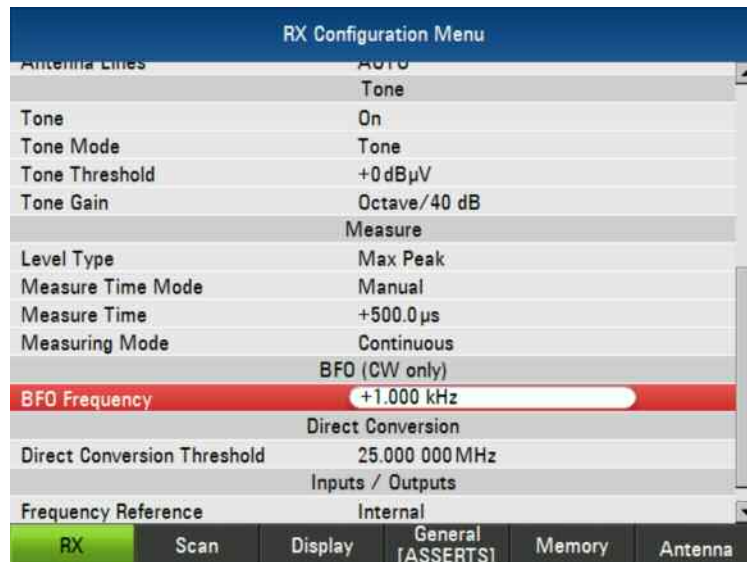

Beat Frequency Oscillator (BFO):

Use this field to set the BFO frequency. Please note that this value is irrelevant unless the demodulation mode is CW. Adjustable from -8.000 kHz to +8 kHz.

7.1.6 Direct Conversion Threshold

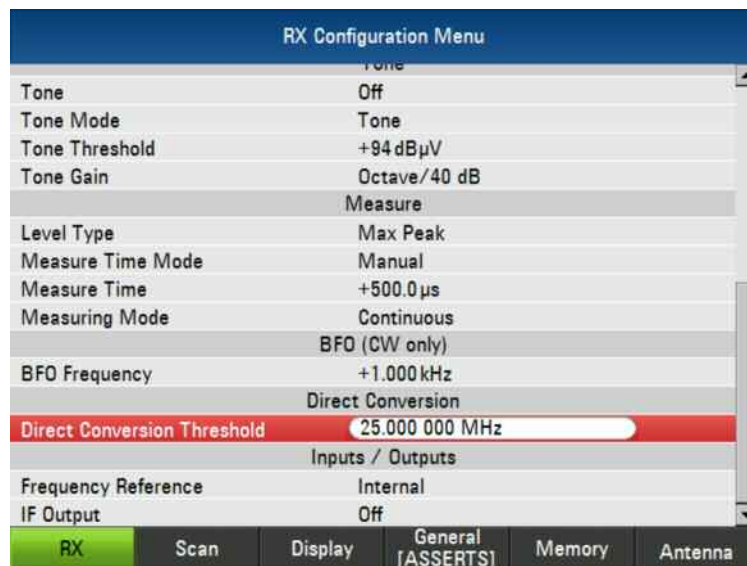

Direct Conversion Threshold:

Setting up the conversion Threshold. Adjustable from 20.000 000 MHz to 30.000 000 MHz.

7.1.7 Inputs / Outputs

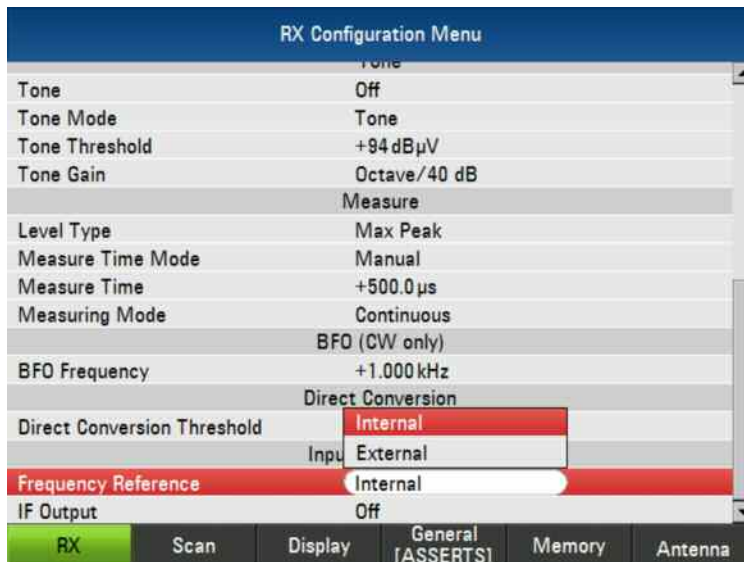

Frequency Reference:

Choose between INTERNAL or EXTERNAL reference.

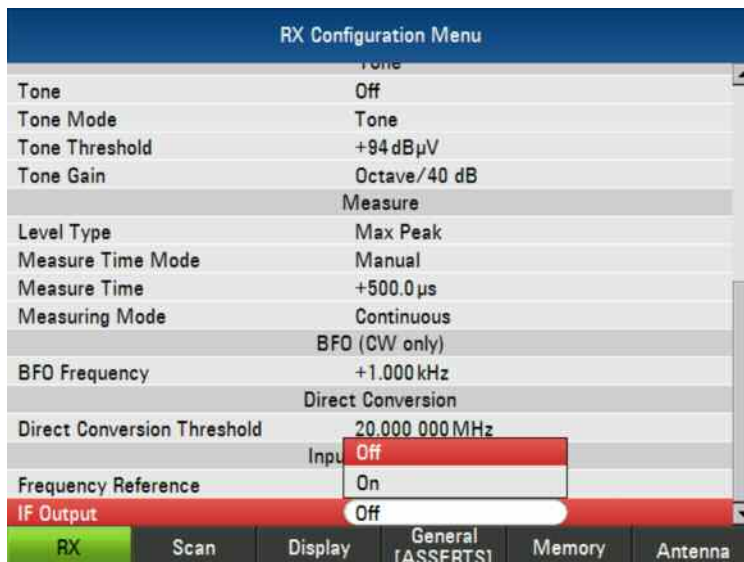

IF Output:

Select this menu-item to switch the IF Output ON or OFF.

7.2 Scan Configuration Menu

7.2.1 Frequency Scan

| Scan Configuration Menu | |
|--------------------------------|-------------------|
| Frequency Scan | |
| Scan Start Frequency | 70.000 000 MHz |
| Scan Stop Frequency | 140.000 000 MHz |
| Frequency Scan Stepsize | 0.100 000 MHz |
| RF Panorama Scan Resolution BW | 100 kHz |
| Memory Scan | |
| Scan Start Line | 000 |
| Scan Stop Line | 099 |
| Use Squelch From Memory | Off |
| Scan Options | |
| No Signal Time Mode | Off |
| No Signal Time | +0.0 s |
| Dwell Time Mode | Manual |
| Dwell Time | +0.5 s |
| Scan Cycle Mode | Infinite |
| Number of Cycles | 001 |
| RX | Scan |
| Display | General [ASSERTS] |
| Memory | Antenna |

Scan Start Frequency:

Setting up the start frequency for the frequency scan.

| Scan Configuration Menu | |
|--------------------------------|-------------------|
| Frequency Scan | |
| Scan Start Frequency | 70.000 000 MHz |
| Scan Stop Frequency | 140.000 000 MHz |
| Frequency Scan Stepsize | 0.100 000 MHz |
| RF Panorama Scan Resolution BW | 100 kHz |
| Memory Scan | |
| Scan Start Line | 000 |
| Scan Stop Line | 099 |
| Use Squelch From Memory | Off |
| Scan Options | |
| No Signal Time Mode | Off |
| No Signal Time | +0.0 s |
| Dwell Time Mode | Manual |
| Dwell Time | +0.5 s |
| Scan Cycle Mode | Infinite |
| Number of Cycles | 001 |
| RX | Scan |
| Display | General [ASSERTS] |
| Memory | Antenna |

Scan Stop Frequency:

Setting up the stop frequency for the frequency scan.

| Scan Configuration Menu | |
|---|-----------------|
| Frequency Scan | |
| Scan Start Frequency | 70.000 000 MHz |
| Scan Stop Frequency | 140.000 000 MHz |
| Frequency Scan Step size | 0.100 000 MHz |
| RF Panorama Scan Resolution BW | 100 kHz |
| Memory Scan | |
| Scan Start Line | 000 |
| Scan Stop Line | 099 |
| Use Squelch From Memory | Off |
| Scan Options | |
| No Signal Time Mode | Off |
| No Signal Time | +0.0 s |
| Dwell Time Mode | Manual |
| Dwell Time | +0.5 s |
| Scan Cycle Mode | Infinite |
| Number of Cycles | 001 |
| RX Scan Display General [ASSERTS] Memory Antenna | |

Frequency Scan Step size:

Setting up the step size frequency for the frequency scan from 1 Hz to 1 GHz

| Scan Configuration Menu | |
|---|-----------------|
| Frequency Scan | |
| Scan Start Frequency | 70.000 000 MHz |
| Scan Stop Frequency | 140.000 000 MHz |
| Frequency Scan Step size | 0.100 000 MHz |
| RF Panorama Scan Resolution BW | 100 kHz |
| | 1.25 kHz |
| | 2.5 kHz |
| | 3.125 kHz |
| | 6.25 kHz |
| | 12.5 kHz |
| | 25 kHz |
| | 50 kHz |
| | 100 kHz |
| Scan Start Line | 000 |
| Scan Stop Line | 099 |
| Use Squelch From Memory | Off |
| Scan Options | |
| No Signal Time Mode | Off |
| No Signal Time | +0.0 s |
| Dwell Time Mode | Manual |
| Dwell Time | +0.5 s |
| Scan Cycle Mode | Infinite |
| Number of Cycles | 001 |
| RX Scan Display General [ASSERTS] Memory Antenna | |

RF Panorama Scan Resolution BW:

Select the resolution BW for the panorama scan.

Available resolution BWs: 125 Hz, 250 Hz, 500 Hz, 625 Hz, 1.25 kHz, 2.5 kHz, 3.125 kHz, 6.25 kHz, 12.5 kHz, 25 kHz, 50 kHz, 100 kHz

7.3 Memory Scan

| Scan Configuration Menu | |
|--------------------------------|-------------------|
| Frequency Scan | |
| Scan Start Frequency | 70.000 000 MHz |
| Scan Stop Frequency | 140.000 000 MHz |
| Frequency Scan Step size | 0.100 000 MHz |
| RF Panorama Scan Resolution BW | 100 kHz |
| Memory Scan | |
| Scan Start Line | 000 |
| Scan Stop Line | 099 |
| Use Squelch From Memory | Off |
| Scan Options | |
| No Signal Time Mode | Off |
| No Signal Time | +0.0 s |
| Dwell Time Mode | Manual |
| Dwell Time | +0.5 s |
| Scan Cycle Mode | Infinite |
| Number of Cycles | 001 |
| RX | Scan |
| Display | General [ASSERTS] |
| Memory | Antenna |

Scan Start Line:

Select the start line for the memory scan. Max. lines: 1024

| Scan Configuration Menu | |
|--------------------------------|-------------------|
| Frequency Scan | |
| Scan Start Frequency | 70.000 000 MHz |
| Scan Stop Frequency | 140.000 000 MHz |
| Frequency Scan Step size | 0.100 000 MHz |
| RF Panorama Scan Resolution BW | 100 kHz |
| Memory Scan | |
| Scan Start Line | 000 |
| Scan Stop Line | 099 |
| Use Squelch From Memory | Off |
| Scan Options | |
| No Signal Time Mode | Off |
| No Signal Time | +0.0 s |
| Dwell Time Mode | Manual |
| Dwell Time | +0.5 s |
| Scan Cycle Mode | Infinite |
| Number of Cycles | 001 |
| RX | Scan |
| Display | General [ASSERTS] |
| Memory | Antenna |

Scan Stop Line:

Select the stop line for the memory scan. Max. lines: 1024

| Scan Configuration Menu | |
|---|-----------------|
| Frequency Scan | |
| Scan Start Frequency | 70.000 000 MHz |
| Scan Stop Frequency | 140.000 000 MHz |
| Frequency Scan Step size | 0.100 000 MHz |
| RF Panorama Scan Resolution BW | 100 kHz |
| Memory Scan | |
| Scan Start Line | 000 |
| Scan Stop Line | 099 |
| Use Squelch From Memory | Off |
| No Signal Time Mode | On |
| No Signal Time | +0.0 s |
| Dwell Time Mode | Manual |
| Dwell Time | +0.5 s |
| Scan Cycle Mode | Infinite |
| Number of Cycles | 001 |
| RX Scan Display General [ASSERTS] Memory Antenna | |

Use Squelch From Memory:

Select this menu-item to switch using squelch from memory ON or OFF.

7.3.1 Scan Options

| Scan Configuration Menu | |
|---|-----------------|
| Frequency Scan | |
| Scan Start Frequency | 70.000 000 MHz |
| Scan Stop Frequency | 140.000 000 MHz |
| Frequency Scan Step size | 0.100 000 MHz |
| RF Panorama Scan Resolution BW | 100 kHz |
| Memory Scan | |
| Scan Start Line | 000 |
| Scan Stop Line | 099 |
| Use Squelch From Memory | Off |
| Scan Options | |
| No Signal Time Mode | Off |
| No Signal Time | Off |
| Dwell Time Mode | Variable |
| Dwell Time | +0.5 s |
| Scan Cycle Mode | Infinite |
| Number of Cycles | 001 |
| RX Scan Display General [ASSERTS] Memory Antenna | |

No Signal Time Mode:

Choose between OFF or VARIABLE for the no signal time mode.

| Scan Configuration Menu | |
|---|-----------------|
| Frequency Scan | |
| Scan Start Frequency | 70.000 000 MHz |
| Scan Stop Frequency | 140.000 000 MHz |
| Frequency Scan Stepsize | 0.100 000 MHz |
| RF Panorama Scan Resolution BW | 100 kHz |
| Memory Scan | |
| Scan Start Line | 000 |
| Scan Stop Line | 099 |
| Use Squelch From Memory | Off |
| Scan Options | |
| No Signal Time Mode | Variable |
| No Signal Time | +0.0 s |
| Dwell Time Mode | Manual |
| Dwell Time | +0.5 s |
| Scan Cycle Mode | Infinite |
| Number of Cycles | 001 |
| RX Scan Display General [ASSERTS] Memory Antenna | |

No Signal Time:

Setting up the no signal time. Adjustable from 0.0 s to 60 s

| Scan Configuration Menu | |
|---|-----------------|
| Frequency Scan | |
| Scan Start Frequency | 70.000 000 MHz |
| Scan Stop Frequency | 140.000 000 MHz |
| Frequency Scan Stepsize | 0.100 000 MHz |
| RF Panorama Scan Resolution BW | 100 kHz |
| Memory Scan | |
| Scan Start Line | 000 |
| Scan Stop Line | 099 |
| Use Squelch From Memory | Off |
| Scan Options | |
| No Signal Time Mode | Off |
| No Signal Time | +0.0 s |
| Dwell Time Mode | Manual |
| Dwell Time | Infinite |
| Scan Cycle Mode | Manual |
| Number of Cycles | 001 |
| RX Scan Display General [ASSERTS] Memory Antenna | |

Dwell Time Mode:

Choose between MANUAL or INFINITE for the no dwell time mode.

| Scan Configuration Menu | | | | | |
|--------------------------------|-----------------|---------|-------------------|--------|---------|
| Frequency Scan | | | | | |
| Scan Start Frequency | 70.000 000 MHz | | | | |
| Scan Stop Frequency | 140.000 000 MHz | | | | |
| Frequency Scan Step size | 0.100 000 MHz | | | | |
| RF Panorama Scan Resolution BW | 100 kHz | | | | |
| Memory Scan | | | | | |
| Scan Start Line | 000 | | | | |
| Scan Stop Line | 099 | | | | |
| Use Squelch From Memory | Off | | | | |
| Scan Options | | | | | |
| No Signal Time Mode | Off | | | | |
| No Signal Time | +0.0 s | | | | |
| Dwell Time Mode | Manual | | | | |
| Dwell Time | +0.5 s | | | | |
| Scan Cycle Mode | Infinite | | | | |
| Number of Cycles | 001 | | | | |
| RX | Scan | Display | General [ASSERTS] | Memory | Antenna |

Dwell Time:

Setting up the dwell time. Adjustable from 0.0 s to 60 s.

| Scan Configuration Menu | | | | | |
|--------------------------------|-----------------|---------|-------------------|--------|---------|
| Frequency Scan | | | | | |
| Scan Start Frequency | 70.000 000 MHz | | | | |
| Scan Stop Frequency | 140.000 000 MHz | | | | |
| Frequency Scan Step size | 0.100 000 MHz | | | | |
| RF Panorama Scan Resolution BW | 100 kHz | | | | |
| Memory Scan | | | | | |
| Scan Start Line | 000 | | | | |
| Scan Stop Line | 099 | | | | |
| Use Squelch From Memory | Off | | | | |
| Scan Options | | | | | |
| No Signal Time Mode | Off | | | | |
| No Signal Time | +0.0 s | | | | |
| Dwell Time Mode | Infinite | | | | |
| Dwell Time | Manual | | | | |
| Scan Cycle Mode | Infinite | | | | |
| Number of Cycles | 001 | | | | |
| RX | Scan | Display | General [ASSERTS] | Memory | Antenna |

Scan Cycle Mode:

Choose between MANUAL or INFINITE for the no scan cycle mode.

| Scan Configuration Menu | |
|--------------------------------|-----------------|
| Frequency Scan | |
| Scan Start Frequency | 70.000 000 MHz |
| Scan Stop Frequency | 140.000 000 MHz |
| Frequency Scan Step Size | 0.100 000 MHz |
| RF Panorama Scan Resolution BW | 100 kHz |
| Memory Scan | |
| Scan Start Line | 000 |
| Scan Stop Line | 099 |
| Use Squelch From Memory | Off |
| Scan Options | |
| No Signal Time Mode | Off |
| No Signal Time | +0.0 s |
| Dwell Time Mode | Manual |
| Dwell Time | +0.5 s |
| Scan Cycle Mode | Manual |
| Number of Cycles | 0001 |

Number of Cycles:

Enter the number of cycles for the scans. Only selectable if scan cycle mode is Manual.

Max. Number of Cycles: 1000

7.4 Display

7.4.1 RX Screen

| Display Configuration Menu | |
|----------------------------|----------------|
| RX Screen | |
| Level Bar Low Limit | -30 dB μ V |
| Level Bar Range | 60 dB |
| IF-PAN Screen | |
| IF-PAN Level Reference | +95 dB μ V |
| IF-PAN Level Range | 120 dB |
| IF-PAN Span | 10 MHz |
| IF-PAN Display Mode | Max Hold |
| RF-PAN Screen | |
| RF-PAN Level Reference | +50 dB μ V |
| RF-PAN Level Range | 60 dB |
| RF-PAN Display Mode | Max Hold |
| Waterfall Screen | |
| Waterfall Speed | +20.0 lines/s |
| Waterfall Level Reference | +50 dB μ V |
| Waterfall Level Range | 60 dB |

Level Bar Low Limit:

Setting up the low limit for the level bar. Adjustable from -30 dB μ V to +110 dB μ V

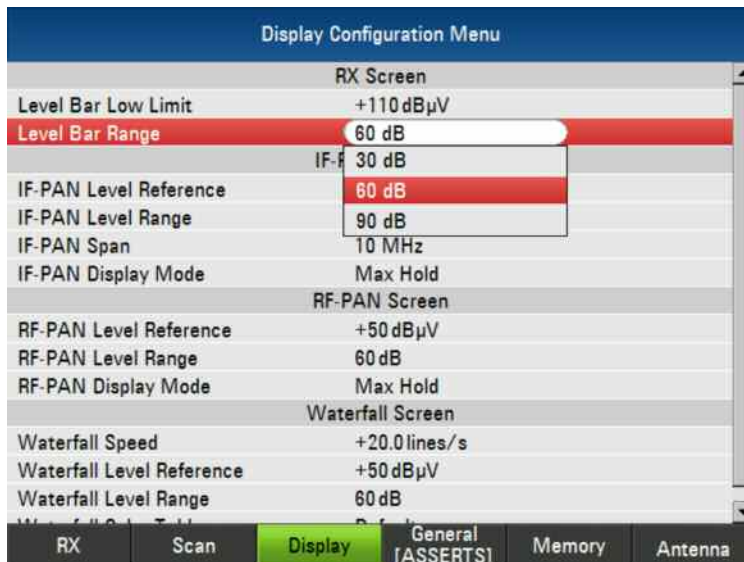

Level Bar Range:

Setting up the level bar range.

Available ranges: 30 dB, 60 dB, 90 dB.

7.4.2 IF-PAN Screen

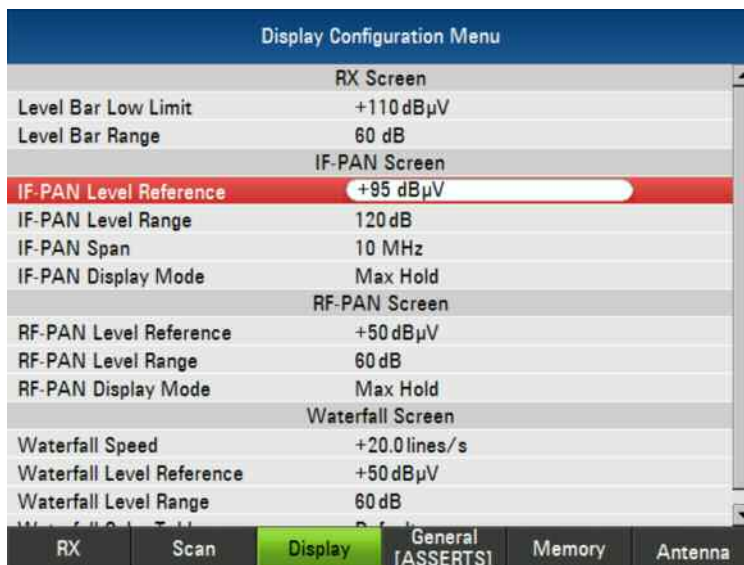

IF-PAN Level Reference:

Setting up the level reference for IF-PAN. Adjustable from -30 dB μ V to +110 dB μ V

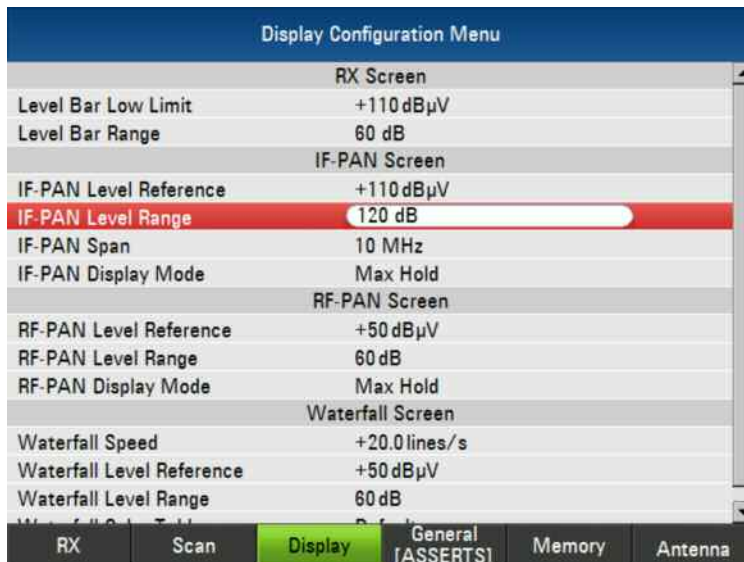

IF-PAN Level Range:

Setting up the IF-PAN level range. Adjustable from 10 dB to 140 dB in 1 dB steps.

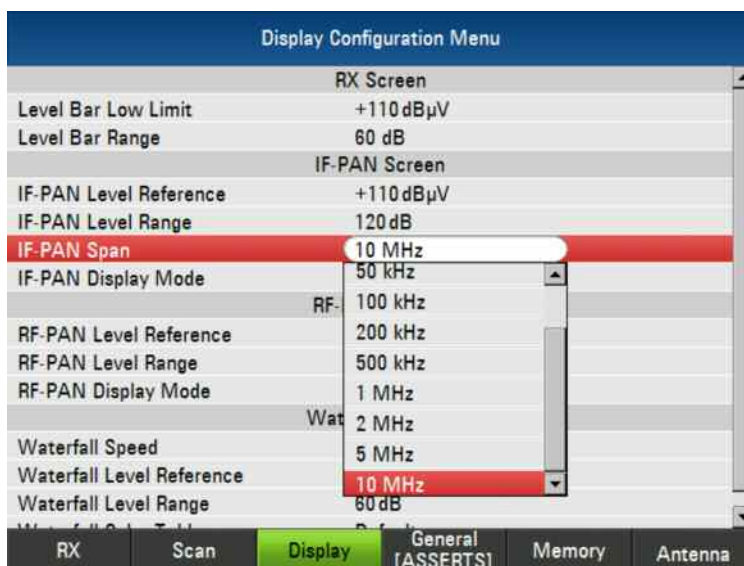

IF-PAN Span:

Select the IF-PAN span.

Available spans: 10 kHz, 20kHz, 50 kHz, 100 kHz, 200 kHz, 200 kHz, 500 kHz, 1 MHz, 2 MHz, 5 MHz, 10 MHz

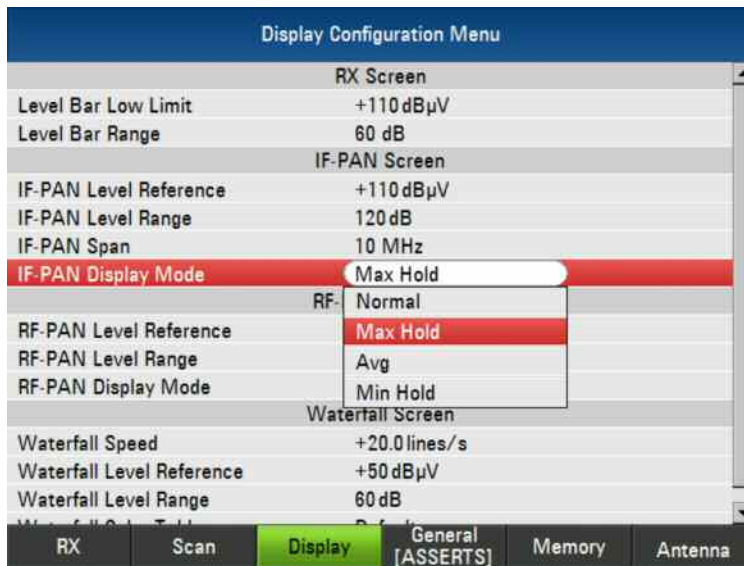

IF-PAN Display Mode:

Select the display mode.

Available modes: Normal, Max Hold, Avg, Min Hold

7.4.3 RF-PAN Screen

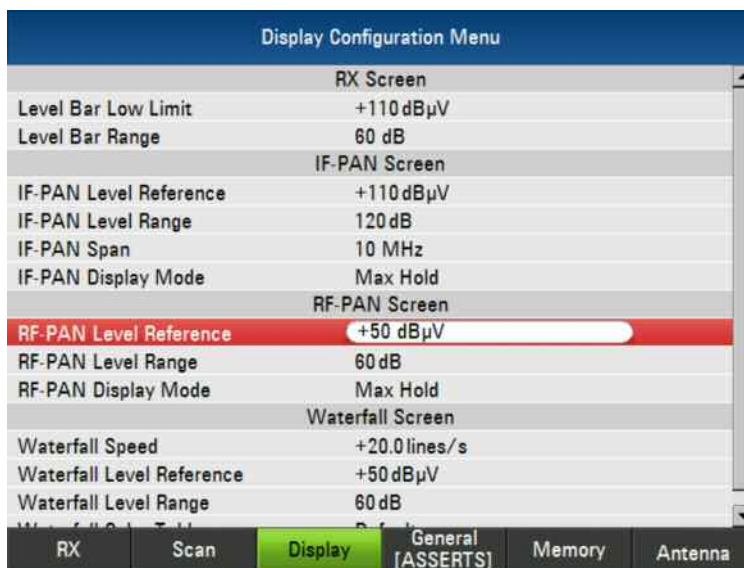

RF-PAN Level Reference:

Setting up the level reference for RF-PAN. Adjustable from -30 dB μ V to +110 dB μ V.

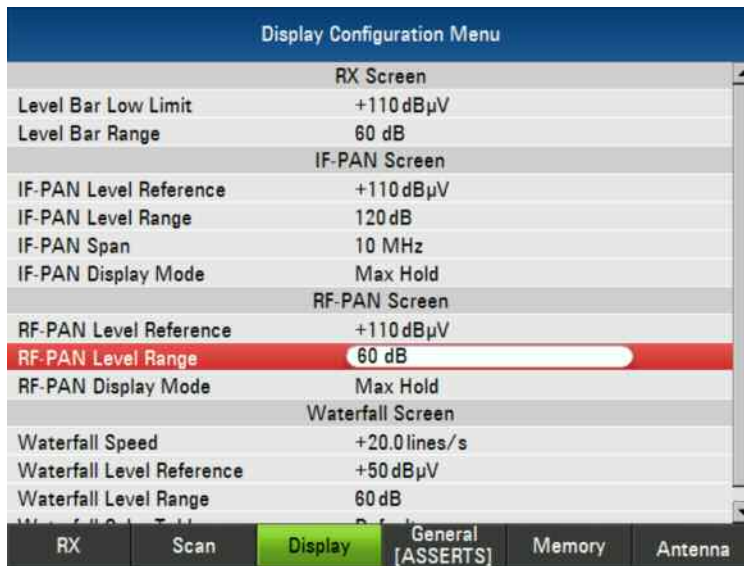

RF-PAN Level Range:

Setting up the RF-PAN level range. Adjustable from 10 dB to 140 dB in 1 dB steps.

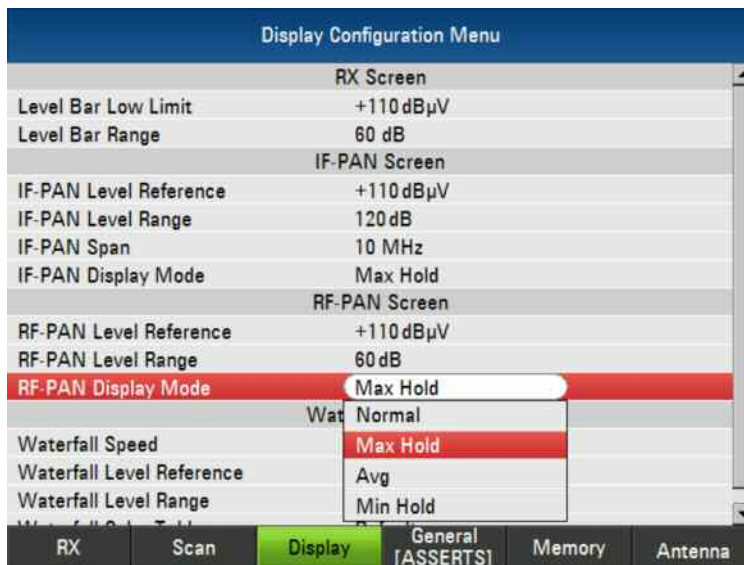

RF-PAN Display Mode:

Select the display mode.

Available modes: Normal, Max Hold, Avg, Min Hold

7.4.4 Waterfall Screen

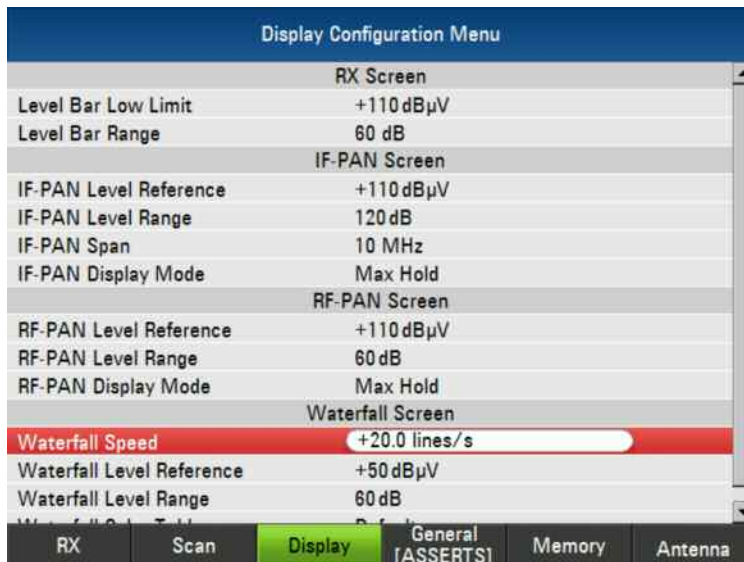

Waterfall Speed:

Setting up the number of lines/s. Adjustable from 0.1 lines/s to 20 lines/s

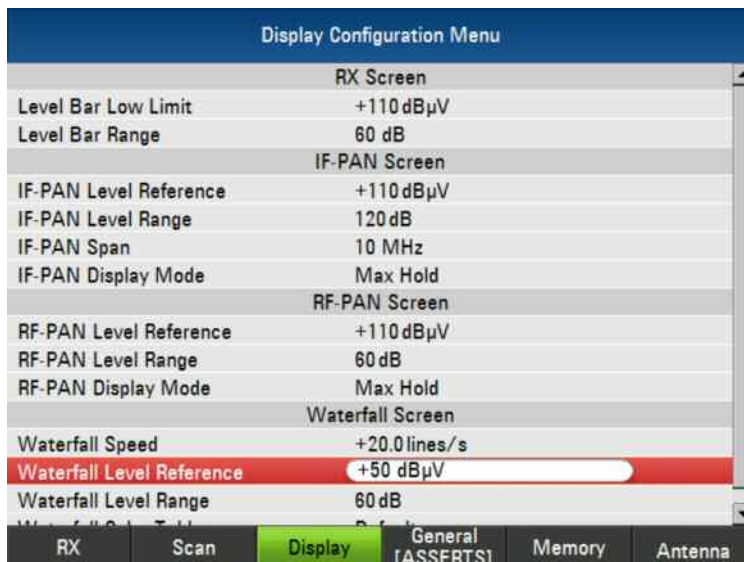

Waterfall Level Reference:

Setting up the level reference for the waterfall screen. Adjustable from 30 dB μ V to +110 dB μ V.

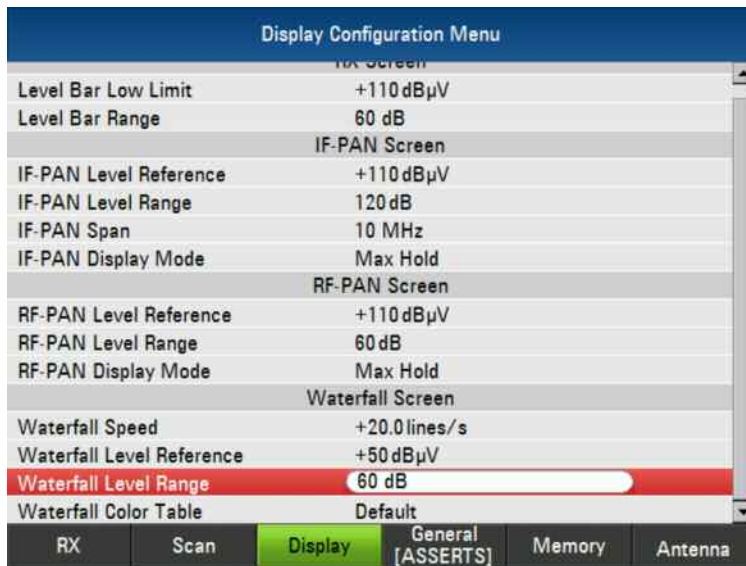

Waterfall Level Range:

Select to adjust the level range for the waterfall. Adjustable from 10 dB to 140 dB in 1 dB steps.



Waterfall Color Table:

Select to setting up the colors for the waterfall screen.
Available tables: Green-Yellow, Green-Blue, Black-White, Red-Purple, Blue-Black

7.5 General Configuration Menu

7.5.1 General

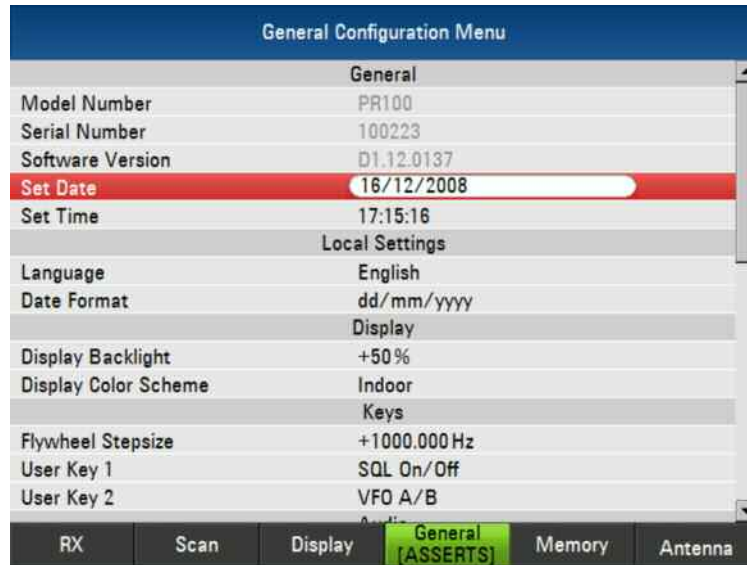

Set Date:

Setting up the date.

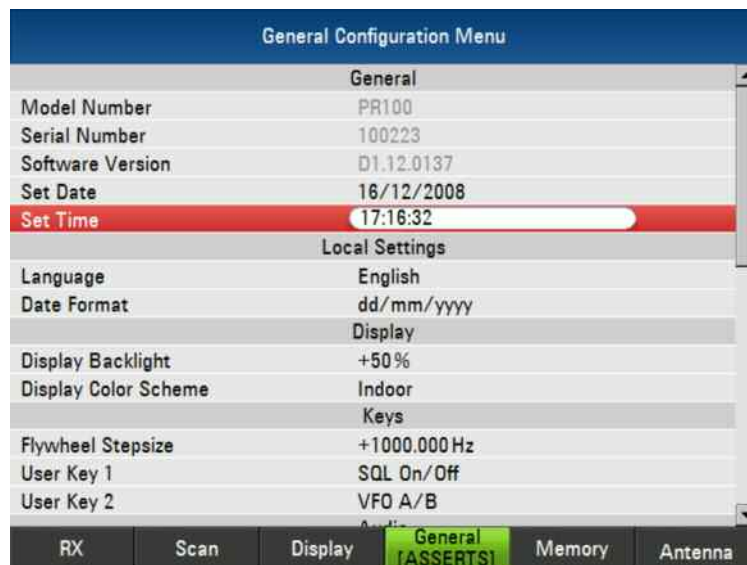

Set Time:

Setting up the time.

7.5.2 Local Settings



Language:

Select your preferred language.

Available languages: English, Portuguese, French



Date Format:

Setting up the date format.

Available formats: dd/mm/yyyy, mm/dd/yyyy

7.5.3 Display

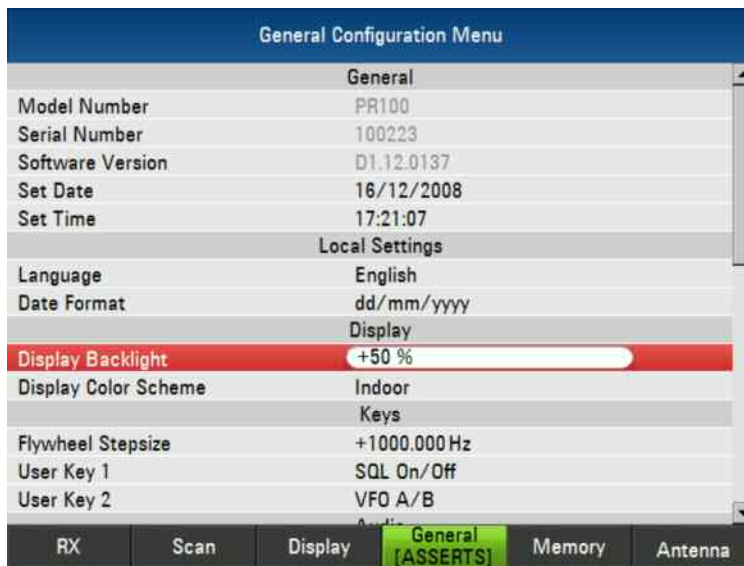

Display Backlight:

Setting up the backlight. Adjustable from 0% to 100%.
Be careful! If 0% backlight is selected, the display will be black!

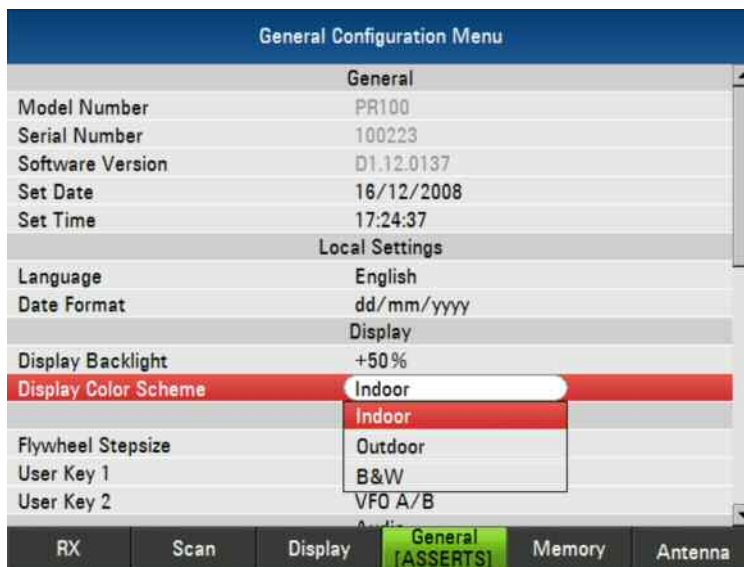

Display Color Scheme:

Select the display color scheme.
Available schemes: Indoor, Outdoor, B&W (Black and White)

7.5.4 Keys

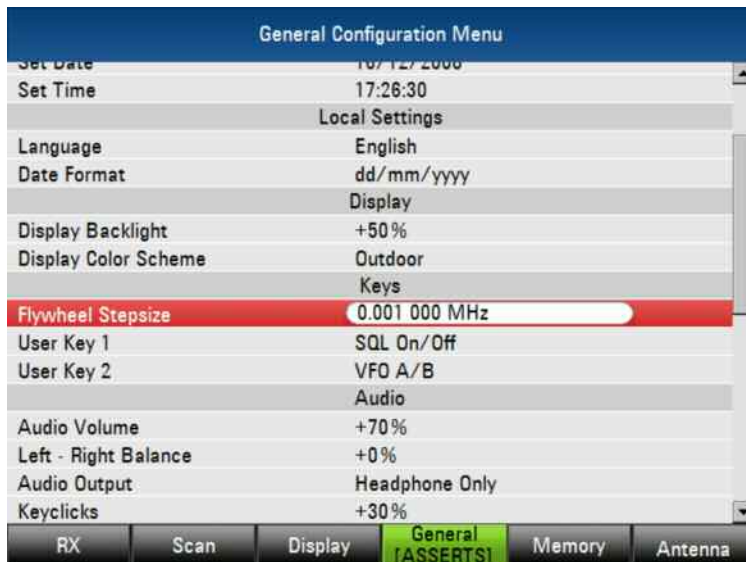

Flywheel Stepsize:

Setting up the stepsize for the flywheel: Adjustable from 1Hz to 500MHz.

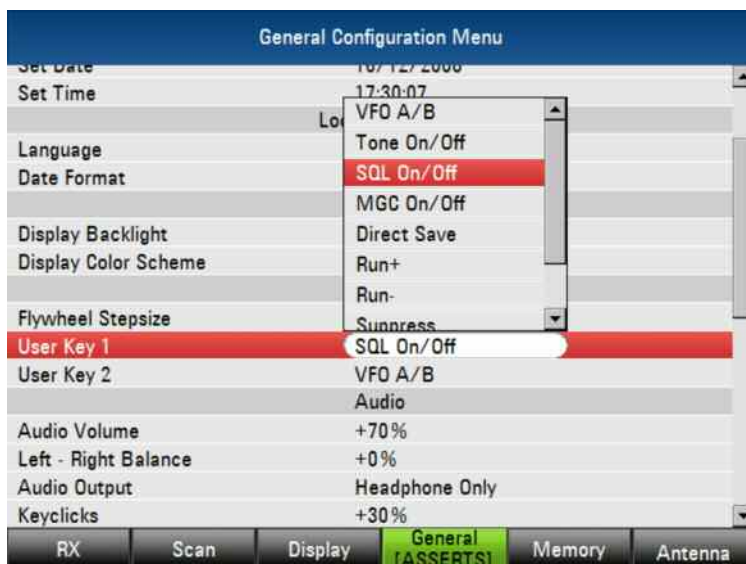

User Key 1:

Setting up the function for the user key 1.

Available functions: VFO A/B, Tone On/Off, SQL On/Off, MGC On/Off, Direct Save, Run+, Run-, Suppress.



User Key 2:

Setting up the function for the user key 2.

Available functions: VFO A/B, Tone On/Off, SQL On/Off, MGC On/Off, Direct Save, Run+, Run-, Suppress.

7.5.5 Audio

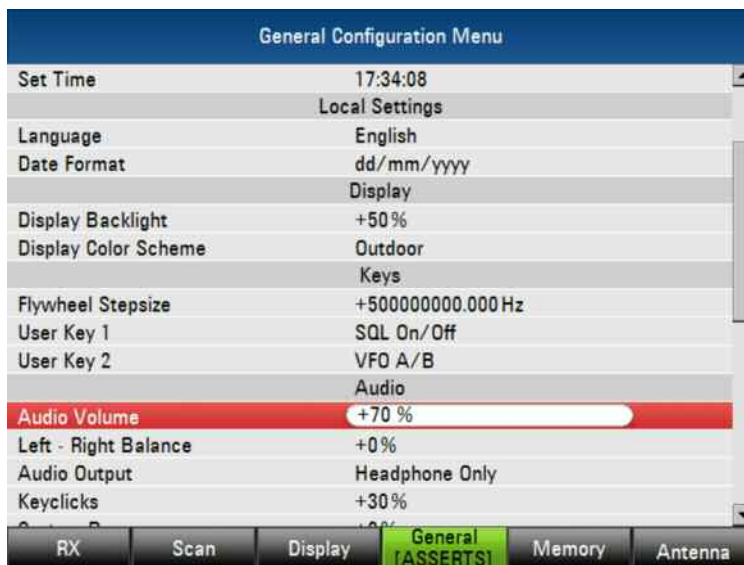

Audio Volume:

Setting up the volume for the audio output. Adjustable from 0% to 100%

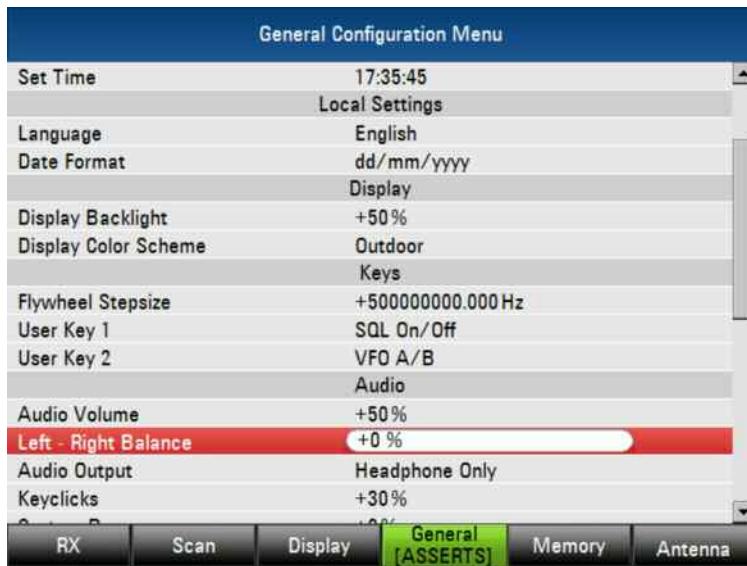

Left – Right Balance:

Setting up the audio balance. Adjustable from -50% to +50%.

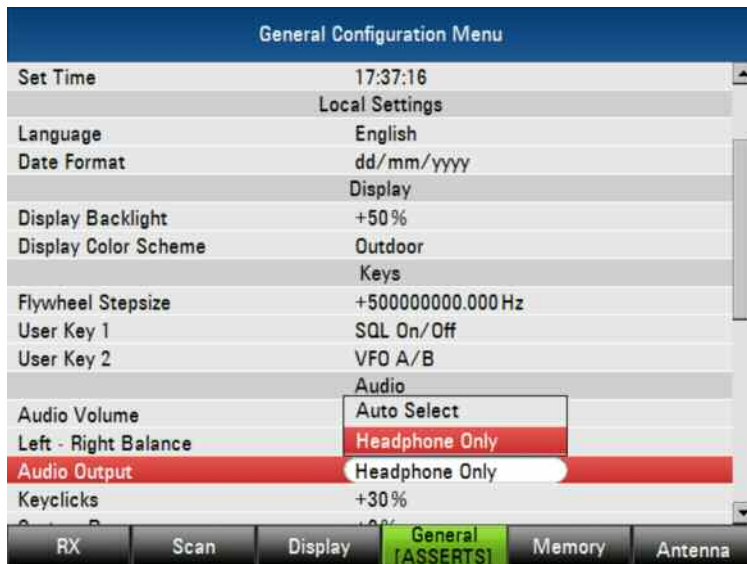

Audio Output:

Select the audio output mode.

Available modes: Auto Select, Headphone Only

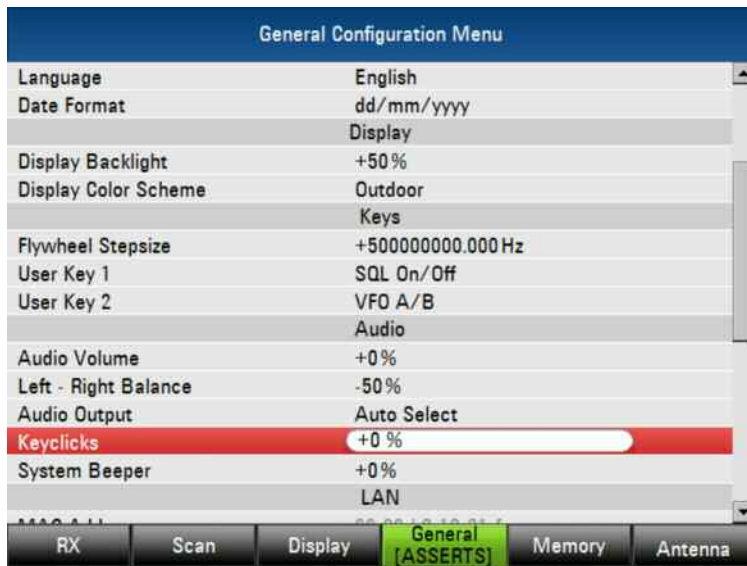

Keyclicks:

Setting up the volume for the key clicks. Adjustable from 0% to 100%.

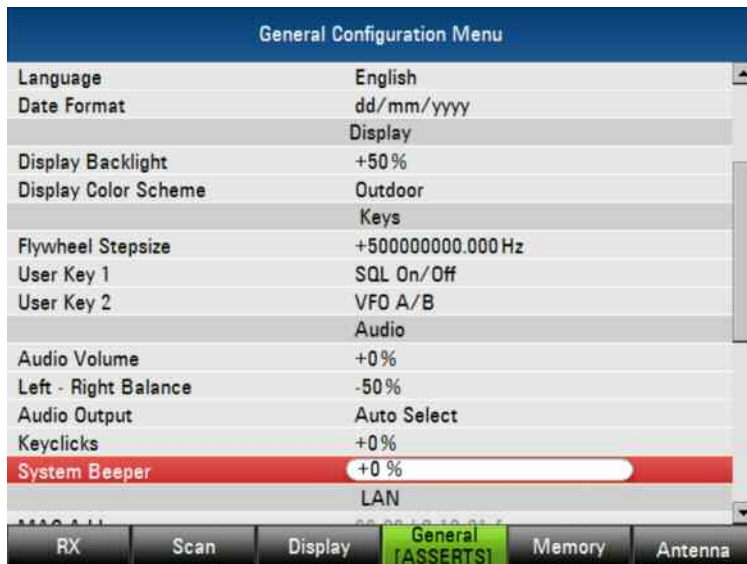

System Beeper:

Setting up the volume for the system beeper. Adjustable from 0% to 100%

7.5.6 LAN

**DHCP:**

Enable or disable DHCP.

**IP-Address:**

Setting up the IP-Address. Default: 172.17.75.1



Subnet Mask:

Setting up the subnet mask. Default: 255.255.255.0



Port:

Setting up the port. Default for LAN: 5555



Reset to Factory Settings:
Select to reset all settings.

7.6 Memory Configuration Menu

7.6.1 Direct Save & Auto Save

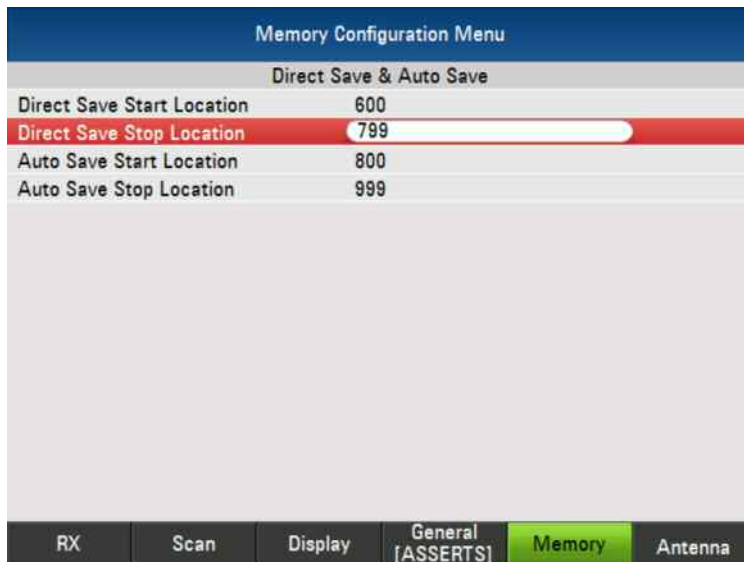

Direct Save Start Location:
Setting up the start location for the direct save function.

**Direct Save Stop Location:**

Setting up the stop location for the direct save function.

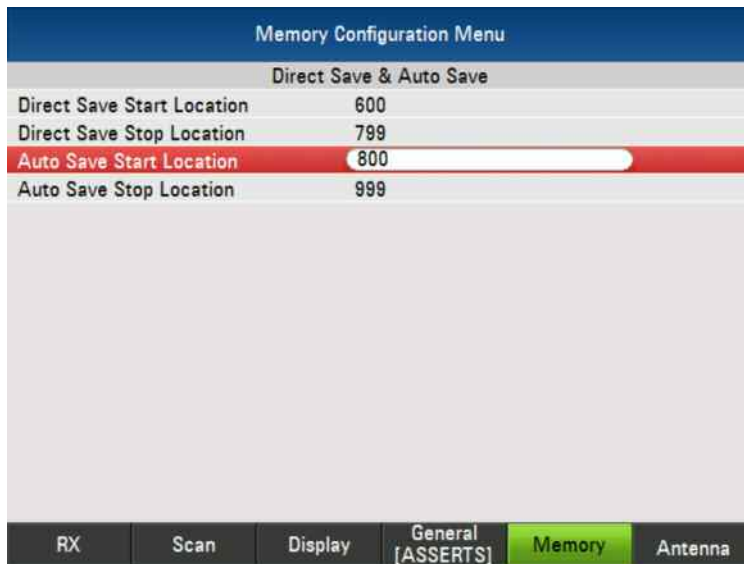
**Auto Save Start Location:**

Setting up the start location for the auto save function.

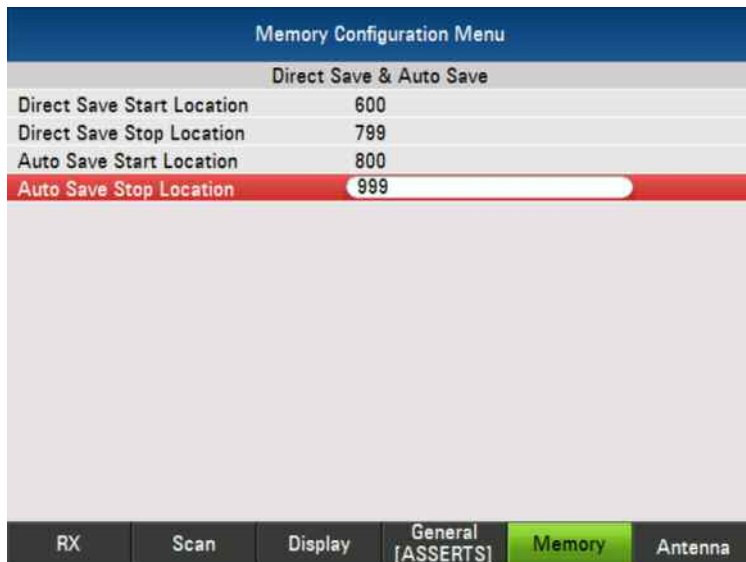

Auto Save Stop Location:

Setting up the stop location for the auto save function.

7.7 Antenna Configuration Menu



Only Available with the Field Strength Measurement Option.

Include: Include or exclude an antenna.

Select: Activate or deactivate an antenna.

View: Shows the antenna configuration.

Exit: Leave the antenna configuration menu.

8 SCPI Interface

8.1 Document Outline

The SCPI standard describes an interface with which instruments can be controlled. The idea behind SCPI is that it should not matter what kind of instrument measures e.g. a voltage level, be it a multimeter or a radio scanner measuring the voltage at the antenna output; the command should always be the same. Although theoretically possible, in practice this goal is unachievable. However, the goal of every instrument designer is to stay as close to SCPI as possible.

The goal of every instrument designer is to stay as close to SCPI as possible. In addition, the PR100 tries to be backward compatible with its predecessor, the EB200 Miniport Receiver, when possible. In fact, this compatibility requirement outweighs the SCPI compliance requirement. Therefore, the SCPI interface for the PR100 is defined with the following rules:

1. If an EB200 SCPI command relates to functionality that is not supported by the PR100, the command is not supported either.
2. If a function can be done via an existing EB200 SCPI command, that command is supported.
3. If a function cannot be done via an existing EB200 SCPI command, but a suitable SCPI compliant command is available, the SCPI compliant command is supported.
4. Otherwise, a new SCPI-like command is added, specific for the PR100

Each command is described in detail in Chapter 11.

A command is rarely useful if no data can be retrieved to monitor its effect. In SCPI, this is done via queries. Queries can be used to retrieve the settings of an instrument. However, measurements can consist of large sets of data. Outputting that over the SCPI interface could delay the reaction time to commands, which is why the PR100 also offers the data in another format that can be sent via the UDP/IP protocol (internet).

8.2 Legend

Abbreviations Used

| <i>Abbreviation</i> | <i>Meaning</i> |
|---------------------|----------------|
|---------------------|----------------|

| Abbreviation | Meaning |
|---------------------|--|
| ASCII | American Standard Code for Information Interchange |
| NA | Not Applicable |
| SCPI | Standard Commands for Programmable Instruments |
| ESE | Event Status Enable |
| ESR | Event Status Register |
| IP | Internet Protocol |
| IST | Individual STatus |
| LSB | Least Significant Byte |
| MAV | Message AVailable |
| MR | Monitoring Receiver |
| MSB | Most Significant Byte |
| NTR | Negative TRansition |
| PRE | Parallel Poll Register Enable |
| PTR | Positive TRansition |
| SRE | Service Request Enable |
| SRQ | Service ReQuest |
| STB | STatus Byte |
| UDP | User Datagram Protocol |

9 SCPI Commands

9.1 SCPI introduction

SCPI (Standard Commands for Programmable Instruments) describes a standard command set for programming devices, irrespective of the type of device or manufacturer. The goal of the SCPI consortium is to standardize the device-specific commands to a large extent. For this purpose, a model was developed that defines the same functions for different devices. Command systems were generated that are assigned to these functions. Thus it is possible to address the same functions with identical commands. The command systems are of a hierarchical structure. Figure 1 illustrates this tree structure using a section of command system SENSE which operates the sensor functions of the devices. The other examples regarding syntax and structure of the commands are derived from this command system.

SCPI is based on standard IEEE 488.2, i.e. it uses the same syntactic elements as well as the common commands defined in this standard. Part of the syntax of the device responses is defined with greater restrictions than in standard IEEE 488.2 (see Section 9.1.4).

The commands consist of a so-called header and, in most cases, one or more parameters. Header and parameter are separated by a "white space" (= any number of space characters, ASCII code 32 decimal). The headers may

consist of several keywords. Queries are formed by directly appending a question mark to the header.

9.1.1 Common Command Structure

Common commands consist of a header preceded by an asterisk "*" and one or several parameters, if any.

Examples:

*RST RESET, resets the device

*ESE 253 EVENT STATUS ENABLE, sets the bits of the event status enable register to 253

*ESR? EVENT STATUS QUERY, queries the contents of the event status register.

9.1.2 Device-Specific Command Structure

Hierarchy

Device-specific commands are of hierarchical structure (see Figure 1).

Commands of the highest level (root level) consist of only one keyword. This keyword denotes a complete command system.

Example:

SYSTEM This keyword denotes the command system SYSTEM.

For commands of lower levels, the complete path has to be specified, starting on the left with the highest level, the individual keywords being separated by a colon ":".

Example:

SENSE:FREQUENCY:START 118 MHz

This command lies in the third level of the SENSE system. It sets the starting frequency of a scan to 118 MHz.

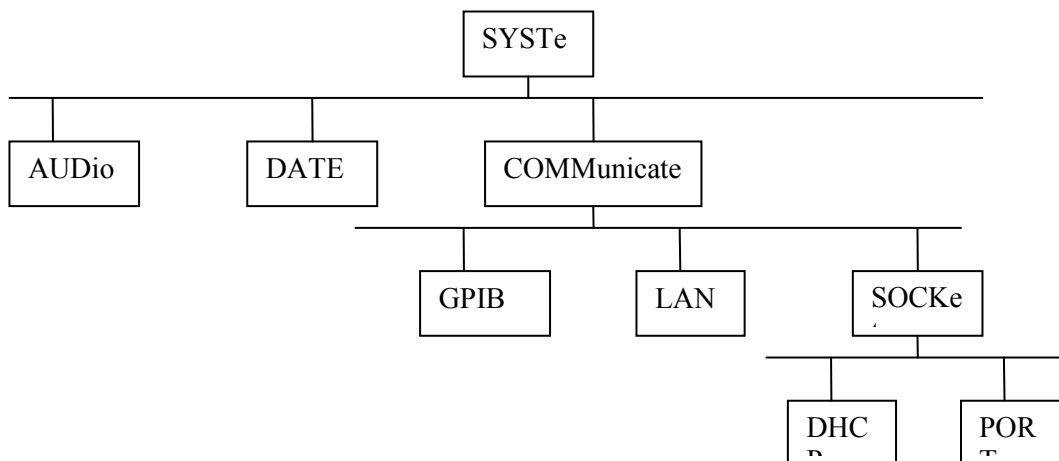

Figure 1: Tree-Structure example of SENSE system

Keywords that occur at several levels within one command system can have different effects.

Example:

MMEMory:CATalog?

List all files in the current directory.

DISPlay:WINDow:CATalog?

List all available display modes.

Optional keywords

Some command systems permit certain keywords to be optionally inserted into a command or omitted. These keywords are marked by square brackets in the description. Some commands are considerably shortened by these optional keywords, although the full command length is also recognized by the device.

Example:

Command description: FORMat[:DATA] ASCii

Full command: FORMat ASCii

Shortened command: FORM ASC

Note: *An optional keyword must not be omitted if its effect is specified in detail by a numeric suffix.*

Long and short form

The keywords can be of a long form or a short form. Either the short form or the long form can be entered, other abbreviations are not permissible.

Example:

Long form: STATus:QUESTionable:ENABle 1

Short form: STAT:QUES:ENAB 1

Note: *The short form is marked by upper-case letters, the long form corresponds to the complete word. Upper-case and lower-case notation only serve the human reader, the device itself does not make any difference between upper- and lower-case letters.*

Parameter

The parameter must be separated from the header by a "white space". If several parameters are specified in a command, they are separated by a comma ",". A few queries permit the parameters MINimum, MAXimum and DEFault to be entered. For a description of the types of parameter, refer to "Parameters" in Section 9.1.5.

Example:

DISPlay:BRIGhtness? MAXimum Response: 1.00

This query requests the maximal value for the display backlight.

Numeric Suffix

If a device features several functions or characteristics of the same kind, the desired function can be selected by a suffix added to the command. Entries without suffix are interpreted like entries with the suffix 1.

9.1.3 Structure of a command line

Several commands in a line are separated by a semicolon ";". If the next command belongs to a different command system, the semicolon is followed by a colon.

Example:

DISPlay:BRIGhtness MAXimum;:SYSTem:AUDio:VOLume MAXimum

This command line contains two commands. The first command is part of the DISPLAY system and is used to specify the level of the display backlight. The second command is part of the SYSTEM system and sets the audio volume to maximum.

If the successive commands belong to the same system, having one or several levels in common, the command line can be abbreviated. To this end, the second command after the semicolon starts with the level that lies below the common levels (see also Figure 1). The colon following the semicolon must be omitted in this case.

Example:

DISPlay:BRIGhtness MAXimum;:DISPlay:DATE:FORMat ddmmyyyy

This command line is represented in its full length and contains two commands separated from each other by the semicolon. Both commands are part of the DISPLAY command system, ie they have one level in common.

When abbreviating the command line, the second command begins with the level below DISPLAY. The colon after the semicolon is omitted.

The abbreviated form of the command line reads as follows:

DISPlay:BRIGhtness MAXimum;DATE:FORMat ddmmyyyy

However, a new command line always begins with the complete path.

Example:

DISPlay:BRIGhtness MAXimum

DISPlay:BRIGhtness 0.5

9.1.4 Responses to queries

A query is defined for each setting command unless explicitly specified otherwise. It is formed by adding a question mark to the associated setting command. According to SCPI, the responses to queries are partly subject to stricter rules than in standard IEEE 488.2.

1. Maximum values, minimum values and all further quantities, which are requested via a special text parameter are returned as numerical values.

Example: SENSE:FREQuency:STARt? MIN
Response: 9000

2. Numerical values are output without a unit. Physical quantities are referred to the basic units.

Example: SENSE:FREQuency:STOP? Response:
100000000 for 100 MHz

3. Truth values <Boolean values> are returned as 0 (for OFF) and 1 (for ON).

Example: OUTPut:IF:STATe? Response: 1

4. Text (character data) is returned in a short form (see also "Parameters" on page 10).

Example: FORMat:BORDER?
 SWAPped

Response:

9.1.5 Parameters

Most commands require a parameter to be specified. The parameters must be separated from the header by a "white space". Permissible parameters are numerical values, Boolean parameters, text, character strings, block data and expressions. The type of parameter required for each command and the permissible range of values are specified in the command description (see Section 9.4).

Numerical values

Numerical values can be entered in several forms, i.e. with sign, decimal point and exponent. Values exceeding the resolution of the device are rounded. The mantissa may comprise up to 41 characters, the exponent must lie inside the value range -37 to 37. The exponent is introduced by an "E" or "e". Entry of the exponent alone is not permissible. In the case of physical quantities, the unit can be entered. Permissible units are as follows:

- for frequencies GHz, MHz or MAHz, kHz and Hz, default unit is Hz
- for times s, ms, μ s, ns; default unit is s
- for levels dB μ V; default unit is dB μ V
- for percentage PCT, default unit PCT

If the unit is missing, the default unit is used. Note that mHz (milli Hz) as a unit is not used to avoid confusion with MHz (mega Hz) since SCPI is case insensitive.

Example:

SENSe:FREQUency:STARt 123 MHz = SENSe:FREQUency:STARt 123E6

Special numerical

The texts MIN, MAX, UP, DOWN, INF, NINF, and NAN are interpreted as special numerical values. In the case of a query, the numerical value is provided.

Example:

Command: SENSe:FREQUency:STARt MINimum

Query: SENSe: FREQUency:STARt? Response: 9000

MIN/MAX MINimum and MAXimum denote the minimum and maximum value.

UP/DOWN UP, DOWN increases or decreases the numerical value by one step. The step width can be specified for most parameters with a separate command. Some parameters can only be changed in fixed steps (e.g. SENSe:BWIDth UP).

- INF** INFinity stands for $+\infty$. For queries the numerical value 9,9E37 is output.
- NINF** Negative INFinity (NINF) stands for $-\infty$. For queries the numerical value -9,9E37 is output. In a measured-value query, this value is output if the measurement cannot be carried out (e.g. due to a wrong device setting).
- NAN** Not A Number (NAN) stands for results of calculations that are not number. Possible causes are the division by zero, the subtraction of infinity from infinity and simply missing values.. SCPI outputs the value 9,91E37 where NAN is meant. NAN is only sent as a device response, it cannot be entered in a command.

Boolean parameters

Boolean parameters represent two states. The ON state (logically true) is represented by ON or a numerical value unequal to 0. The OFF state (logically untrue) is represented by OFF or the numerical value 0. 0 or 1 is provided in a query.

Example:

Setting command: SYST:COMM:SOCK:DHCP:STAT ON

Query: SYST:COMM:SOCK:DHCP:STAT?

Response: 1

Text

Text parameters (character data) observe the syntactic rules for keywords, i.e. they can be entered using the short or long form. Like any parameter, they have to be separated from the header by a "white space". In the case of a query, the short form of the text is provided.

Example:

Setting command: FORMat:BORDER SWAPped

Query: FORMat:BORDER? Response SWAP

Strings

Strings must always be entered in quotation marks (' or ").

Example:

PROGram:PRESet:DEFine "User Preset 1"

PROGram:PRESet:DEFine 'User Preset 2'

Block Data

Block data (Definite Length Block) are a transmission format which is suitable for the transmission of large amounts of data. A command using a block data parameter has the following structure:

Example:

HEADer:HEADer #45168xxxxxxxx

ASCII character # introduces the data block. The next number indicates how many of the following digits describe the length of the data block. In the example the 4 following digits indicate the length to be 5168 bytes. The data bytes follow; a single character for each byte. Data elements comprising more than one byte are transmitted with the byte being the first that was specified by SCPI command "FORMat:BORDER".

During the transmission of the data bytes all flow-control (e.g End-of-Line) that is sent as an ASCII character is ignored until all bytes are transmitted. Note that e.g. a VXI-11 connection also has flow-control that is not sent as ASCII characters.

Expressions

Expressions must always be in parentheses.

Syntax Elements

Table 1 offers an overview of the syntax elements.

Table 1: Syntax Elements

| Element | Comment |
|---------|---|
| : | The colon separates the key words of a command. In a command line the colon after the separating semicolon marks the uppermost command level. |
| ; | The semicolon separates two commands of a command line. It does not alter the path. |
| , | The comma separates several parameters of a command. |
| ? | The question mark forms a query. |
| * | The asterisk marks a common command. |
| “ | Quotation marks introduce a string and terminate it. |
| # | ASCII character # introduces block data. |
| | A "white space" (ASCII-Code 0 to 9, 11 to 32 decimal, e g blank) separates header and parameter. |
| () | Parentheses enclose an expression (channel lists). |

9.2 Status Reporting

The status reporting system stores all the information on the present operating state of a device and on errors that have occurred. This information is stored in the status registers and in the error queue.

For each remote client of a device there is a separate status reporting system that offers access to all registers of the error queue. The registers form a hierarchical structure. The register "status byte" (STB) defined in IEEE 488.2 and its associated mask register "service request enable" (SRE) form the uppermost level.

The STB receives information from the other registers and evaluates whether an SRQ or IST message has to be generated: The IST flag ("Individual SStatus") and the "parallel poll enable" register (PRE) allocated to it are also part of the status reporting system. The IST flag, like the SRQ, combines the entire device status in a single bit. The PRE fulfils a function for the IST flag as the SRE does for the service request.

For SCPI over TCP/IP, an SRQ is a text-response "&SRQ<CR><LF>", where <CR> is a carriage-return, and <LF> is a line-feed. A C-type string would read as: "&SRQ\r\n".

The message queue contains the messages the device sends back to the controller. It is not part of the status reporting system but determines the value of the "message available" (MAV) bit in STB and is thus shown in Section 9.2.2.2.

Structure of an SCPI status register

Each SCPI register consists of 5 sections each having a width of 16 bits (see Figure 2). Bit 15 (the most significant bit) is set to zero for all sections. Thus the contents of the register sections can be processed by the controller as positive integers. The function of each section is explained below.

CONDition section

The CONDition section of a register reflects directly the state of the hardware. This register section can only be read. Its contents are not changed during reading. As an alternative, a bit in a CONDition register can also contain the summary information of a further status register connected in front. In this case, the bit is cleared only when reading out the root-cause of the bit: another bit in another status register connected in front.

PTRansition section

The Positive-TRansition section acts as an edge detector. When a bit of the CONDition section is changed from 0 to 1, the associated PTR bit decides whether the EVENT bit is set to 1.

PTR bit = 1: the EVENT bit is set.

PTR bit = 0: the EVENT bit is not set.

This section can be written into and read from in any way. Its contents are not changed during reading.

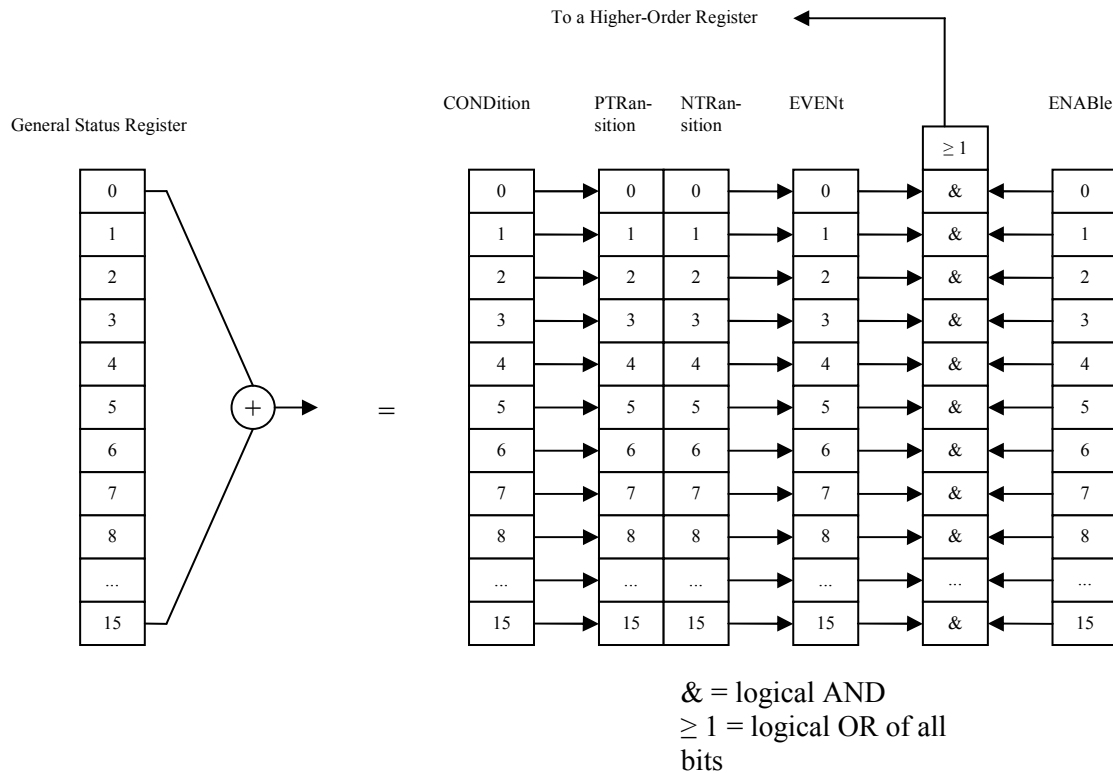

Figure 2: Status Register Model

NTRansition section

The Negative-TTransition section also acts as an edge detector. When a bit of the CONDition section is changed from 1 to 0, the associated NTR bit decides whether the EVENT bit is set to 1.

NTR-bit = 1: the EVENT bit is set.

NTR-bit = 0: the EVENT bit is not set.

This section can be written into and read from in any way. Its contents are not changed during reading.

With these two edge register sections the user can define which state transition of the condition section (none, 0 to 1, 1 to 0 or both) is stored in the EVENT section.

EVENT section

The EVENT section indicates whether an event has occurred since the last reading, it is the "memory" of the CONDition section. It only indicates events passed on by the edge filters. The EVENT section is permanently updated by the device. This part can only be read. During reading, its contents are set to zero. This section is often regarded as the entire register.

ENABle section

The ENABle section determines whether the associated EVENT bit contributes to the summary bit (see below). Each bit of the EVENT section is ANDed with the associated ENABle bit (symbol '&'). The results of all logical operations of this section are passed on to the summary bit via an OR operation (symbol '1').

ENABLE bit = 0: the associated EVENT bit does not contribute to the summary bit

ENABLE bit = 1: if the associated EVENT bit is "1", the summary bit is set to "1" as well.

This section can be written into and read by the user in any way. Its contents is not changed during reading.

Summary bit

As indicated above, the summary bit is obtained from the EVENT and ENABLE section for each register. The result is then entered into a bit of the CONDition section of the higher-order register. The device automatically generates the summary bit for each register. Thus an event, e.g. a PLL that has not locked, can lead to a service request through all the hierarchy levels.

Note

The service request enable register SRE defined in IEEE 488.2 can be taken as ENABLE section of the STB if the STB is structured according to SCPI. By analogy, the ESE can be taken as the ENABLE section of the ESR.

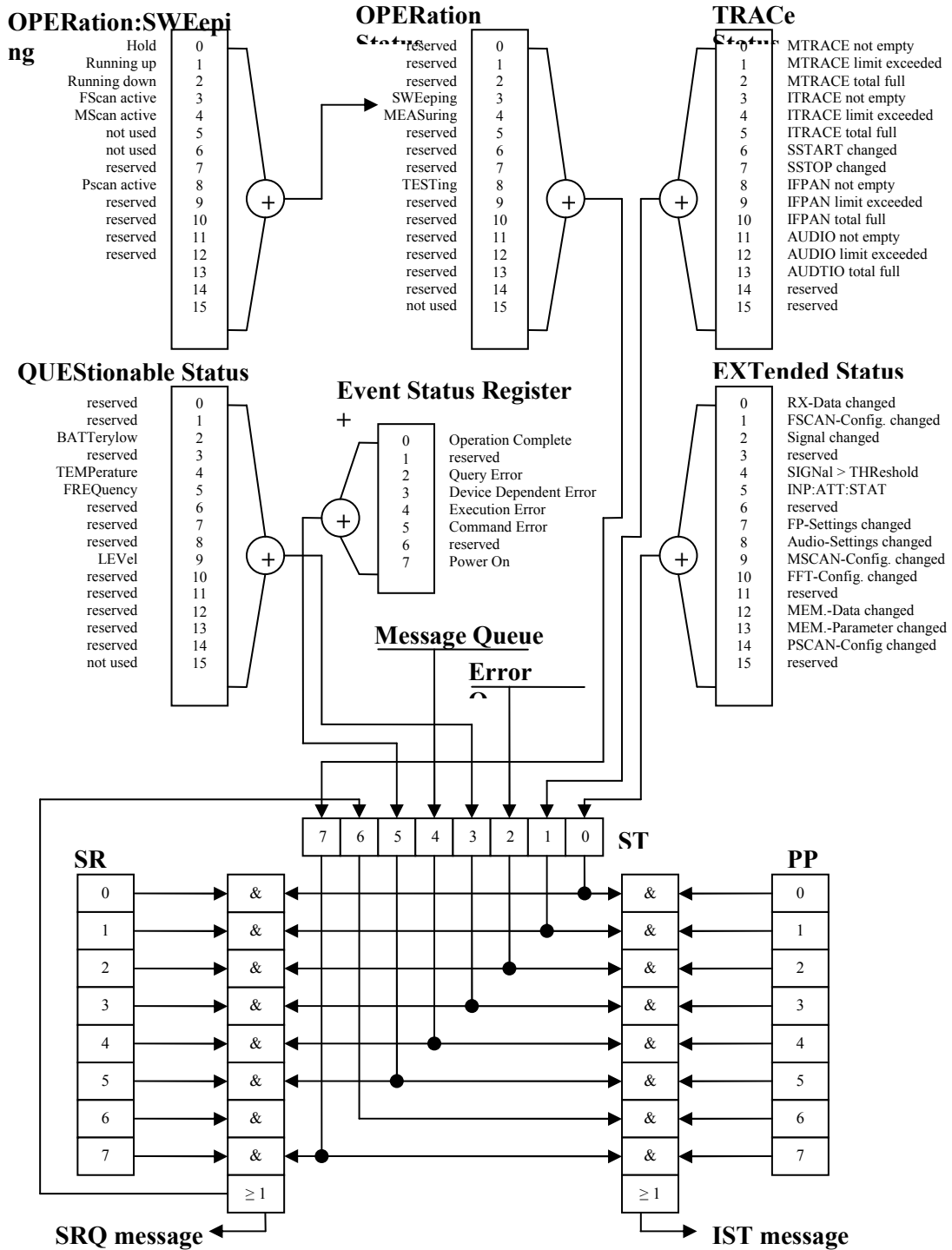

Figure 3: Status Registers

9.2.1 Description of the status registers

9.2.1.1 Status Byte (STB) and Service Request Enable Register (SRE)

The STB is already defined in IEEE 488.2. It provides an overview of the device status by collecting the pieces of information of the lower registers. It can thus be compared with the CONDition section of an SCPI register and

assumes the highest level within the SCPI hierarchy. A special feature is that bit 6 acts as the summary bit of the other bits of the status byte.

The STATUS BYTE is read out using the command "*STB?".

The STB implies the SRE. As to its function, it corresponds to the ENABLE section of the SCPI register. A bit in the SRE is assigned to each bit of the STB. Bit 6 of the SRE is ignored. If a bit is set in the SRE and the associated bit in the STB changes from 0 to 1, a Service Request (SRQ) is generated. The SRE can be set using command "*SRE" and read using "*SRE?".

Table 2: Bit allocation of status byte

| Bit No. | Meaning |
|----------------|---|
| 0 | EXTended status register summary bit The bit is set if an EVENT bit is set in the EXTended-status register and if the corresponding ENABLE bit is set to 1. The states of the hardware functions and change bits are combined in the EXTended-status register. |
| 1 | TRACe status register summary bit The bit is set if an EVENT bit is set in the TRACe-status register and if the corresponding ENABLE bit is set to 1. The states of the TRACes MTRACE, ITRACE, SSTART and SSTOP are represented in the TRACe-status register. |
| 2 | Error Queue not empty The bit is set when the error queue contains an entry. If this bit is enabled by the SRE, an entry into the empty error queue generates a service request. Thus, an error can be recognized and specified in greater detail by polling the error queue. The poll provides an informative error message. |
| 3 | QUESTionable status register summary bit The bit is set if an EVENT bit is set in the QUESTionable-status register and the corresponding ENABLE bit is set to 1. A set bit indicates a questionable device status which can be specified in greater detail by polling the QUESTionable-status register. |
| 4 | MAV bit (message available) This bit is set when the message queue is not empty. |
| 5 | ESB bit Summary bit of the EVENT status register. It is set if one of the bits in the EVENT status register is set and is also enabled in the EVENT status enable register. Setting of this bit implies a serious error which can be specified in greater detail by polling the EVENT status register. |
| 6 | MSS bit (master status summary bit) The bit is set if the device triggers a service request. This is the case if one of the other bits of this register is set together with its mask bit in the service request enable register SRE. |

| Bit No. | Meaning |
|----------------|--|
| 7 | <p>OPERation status register summary bit</p> <p>The bit is set if an EVENT bit is set in the OPERation-status register and the corresponding ENABLE bit is set to 1. A set bit indicates that the device is just performing an action. The type of action can be determined by polling the OPERation-status register.</p> |

9.2.1.2IST flag and Parallel Poll Enable (PPE) register

Analogous to the SRQ message, the IST flag combines the entire status information in a single bit. It can be queried by using command "*IST?". The parallel poll enable register (PPE) determines which bits of the STB contribute to the IST flag. The bits of the STB are ANDed with the corresponding bits of the PPE. In contrast to SRE bit 6 is also used here. The IST flag results from the ORing of all results. The PPE can be set using the "*PRE" commands and read using the "*PRE?" command.

9.2.1.3Event Status Register (ESR) and Event Status Enable (ESE) register

The ESR is already defined in IEEE 488.2. It can be compared with the EVENT section of an SCPI register. The EVENT status register can be read out using the "*ESR?" command.

The ESE is the associated ENABLE section. It can be set using the "*ESE" command and read using the "*ESE?" command.

Table 3: Bit allocation of event status register

| Bit No. | Meaning |
|----------------|---|
| 0 | <p>Operation Complete</p> <p>On receipt of the command *OPC, this bit is set exactly when all previous commands have been executed.</p> |
| 2 | <p>Query Error</p> <p>This bit is set if a query which is faulty and hence cannot be executed.</p> |
| 3 | <p>Device-dependent error</p> <p>This bit is set if a device-dependent error occurs. An error message with a number between -300 and -399 or a positive error number denoting the error in greater detail is entered into the error queue (see Section 9.3).</p> |
| 4 | <p>Execution Error</p> <p>This bit is set if a received command is syntactically correct but cannot be performed for different reasons. An error message with a number between -200 and -299 denoting the error in greater detail is entered into the error queue (see Section 9.3).</p> |

| Bit No. | Meaning |
|----------------|---|
| 5 | Command Error This bit is set if an undefined and syntactically incorrect command is received. An error message with a number between -100 and -199 denoting the error in greater detail is entered into the error queue (see Section 9.3). |
| 7 | Power On (supply voltage on) This bit is set when the device is switched on. |

9.2.1.4 STATUS:OPERation register

In the CONDition section, this register contains information about the type of actions currently being executed by the device. In the EVENT section, it also contains information about the type of actions having been executed since the last reading. It can be read using the commands

"STATUS:OPERation:CONDition?" or
"STATUS:OPERation[:EVENT]?".

Table 4: Bit allocation of STATUS:OPERation register

| Bit No. | Meaning |
|----------------|--|
| 3 | SWEeping This bit is set when the sum bit of STATUS:OPERation:SWEeping bits is set |
| 4 | MEASuring This bit is set for the duration of a measurement |
| 8 | TESTing This bit is set when a self-test is running |

9.2.1.5 STATUS:OPERation:SWEeping register

This register contains more detailed information on the operating state of the device. The device is either set to normal receive mode (Fixed Frequency Mode FFM) or to one of several scan modes (FSCAN, MSCAN, PSCAN). The status is determined by using the command SENSE:FREQUENCY:MODE. The CW|FIXed status is set by clearing bits 3 to 7 from the STATUS:OPERation:SWEeping register.

Table 5: Bit allocation of STATUS:OPERation:SWEeping register

| Bit No. | Meaning |
|----------------|---|
| 0 | Hold This bit is set if an FSCAN or MSCAN was interrupted due to the fulfillment of a hold criterion. |

| Bit No. | Meaning |
|----------------|---|
| 1 | Running up This bit is set if sweeping is to be carried out in the direction of increasing frequency values or memory location numbers. |
| 2 | Running down This bit is set if sweeping is to be carried out in the direction of decreasing frequency values or memory location numbers. |
| 3 | FSCAN active This bit is set if <code>FREQ:MODE</code> is set to <code>SWEep</code> |
| 4 | MSCAN active This bit is set if <code>FREQ:MODE</code> is set to <code>MSCan</code> |
| 5 | not used, always 0 (was used for <code>DSCAN</code> mode in EB200) |
| 6 | not used, always 0 (was used for <code>FASTlevcw</code> mode in EB200) |
| 7 | not used, always 0 (was used for <code>LIST</code> mode in EB200) |
| 8 | PSCAN active This bit is set if <code>FREQ:MODE</code> is set to <code>PSCan</code> |

9.2.1.6 `STATus:TRACe` register

This register contains information on ambiguous states of the traces `MTRACE`, `ITRACE`, `IFPAN`, `SSTART` and `SSTOP`. It can be queried with the commands `STATus:TRACe:CONDition?` or `STATus:TRACe[:EVENT]?`.

Table 6: Bit allocation of STATus:TRACe register

| Bit No. | Meaning |
|----------------|---|
| 0 | MTRACE not empty This bit is set if the MTRACE contains at least one measured value. |
| 1 | MTRACE limit exceeded This bit is set if the number of measured values contained in the MTRACE exceeds the threshold given by the command TRACe:LIMit[:UPPer] MTRACE. |
| 2 | MTRACE total full This bit is set if the MTRACE is loaded with the maximum number of measured values. |
| 3 | ITRACE not empty This bit is set if the ITRACE contains at least one information value. |
| 4 | ITRACE limit exceeded This bit is set if the number of measured values contained in the ITRACE exceeds the threshold given by the command TRACe:LIMit[:UPPer] ITRACE. |
| 5 | ITRACE total full This bit is set if the ITRACE is loaded with the maximum number of information values. |
| 6 | SSTART changed This bit is set if one or several start frequencies of the current suppress table have changed. |
| 7 | SSTOP changed This bit is set if one or several stop frequencies of the current suppress table have changed. |
| 8 | IFPAN not empty This bit is set if at least one measured value is stored under IFPAN. |
| 9 | IFPAN Limit exceeded This bit is set if the number of measured values stored under IFPAN exceeds the threshold set by TRACe:LIMit[:UPPer] IFPAN. |
| 10 | IFPAN total full This bit is set if the maximal number of measured values is stored under IFPAN. |
| 11 | AUDIO not empty This bit is set if some audio data has been recorded. |
| 12 | AUDIO Limit exceeded This bit is set if the information stored under AUDIO exceeds the threshold set by TRACe:LIMit[:UPPer] AUDIO. |
| 13 | AUDIO total full This bit is set if the maximal amount of AUDIO data is stored. |

9.2.1.7 STATUS:EXTension register

This register contains in the CONDition part information on different receiver states which cannot be assigned to the other registers. Information about the actions the unit had carried out since the last read out is stored in the EVENT part. The corresponding registers can be queried with the commands STATUS:EXTension:CONDition? or STATUS:EXTension[:EVENT]? .

Table 7: Bit allocation of STATUS:EXTension register

| Bit No. | Meaning |
|----------------|--|
| 0 | RX data changed This bit is set if the receiver data-set is changed by manual control or by another remote client. See also Table 8. |
| 1 | FSCAN configuration changed This bit is set if the FSCAN data-set is changed by manual control or by another remote client. See also Table 8. |
| 2 | Signal changed This bit is set if the received signal changes in level or offset. The device need not implement a hysteresis, since this bit is only used for test purposes. See also Table 8. |
| 3 | Not Used |
| 4 | SIGNAL > THReshold This bit is set if the signal level is above the squelch threshold (precondition: squelch is switched on). |
| 5 | INPut:ATTenuation:STATe This bit is set if the input attenuator is switched on. |
| 7 | FP settings changed This bit is set if the front-panel data-set is changed by manual control or by another remote client. See also Table 8. |
| 8 | Audio settings changed This bit is set if a parameter was changed by manual control or by another remote client in the data set "miscellaneous". See also Table 8. |
| 9 | MSCAN configuration changed This bit is set if the MSCAN data-set is changed by manual control or by another remote client. See also Table 8. |
| 10 | not used, always 0 (was used for DSCAN in EB200) |
| 12 | MEMory data changed This bit is set if memory data was changed by manual control or by another remote client. See also Table 8. |
| 13 | MEMory parameter changed This bit is set if the memory-query bit was changed. See also Table 8. |

| Bit No. | Meaning |
|----------------|---|
| 14 | PSCAN configuration changed This bit is set if the PSCAN data-set is changed by manual control or by another remote client. See also Table 8. |

With bits 0 to 2 and 7 to 9 and 12 to 14, the host can be informed via an SRQ about parameter changes. Cyclical polling of the settings by the host is thus stopped during manual operation or if the signal parameters are to be indicated. In the CONDition section of the register, the change bits are set after manual control or signal change and are reset by special query commands. Changes done by front panel or by another remote client affect the change bits equally.

Table 8: Change bit-allocation in STATus:EXTension register

| Bit No. | Set by change of: | Reset by query: |
|----------------|---|--|
| 0 | Frequency, demodulation, bandwidth, threshold value, MGC value, control mode, antenna number, attenuation, type of detector, squelch enable, squelch control, sensor function, AFC, TONE mode, tone reference threshold, AUX bit(s), AUX output mode, IF-panorama display width, IF-panorama display mode, measuring time | FREQ?, DEM?, BAND?, GCON:MODE?, INP:ATT:STAT?, DET?, OUTP:SQU?, OUTP:SQU:CONT?, FUNC?, FREQ:AFC?, RX, OUTP:TONE?, OUTP:TONE:THR?, OUTP:BYTAux?, OUTP:AUX?, CALC:IFPAN:AVERTYPE?, CALC:IFPAN:AVER:TIME?, MEAS:TIME? |
| 1 | FSCAN: Start frequency, stop frequency, stepwidth, number of SWE:HOLD:TIME?, runs, synchronizing time, listening time, scan mode | FREQ:STAR?, FREQ:STOP?, SWE:STEP?, SWE:COUN?, SWE:DWEL?, SWE:DIR?, SWE:CONT? |
| 2 | Signal level, offset | SENS:DATA? |
| 7 | Display variants, display mode, display disable, antenna names, display illumination cut-out time, display brightness | DISP:CMAP?, DISP:BRIG?, |
| 8 | Volume, loudspeaker, balance, external reference, tone monitoring | SYST:AUD:VOL?, SYST:AUD:BAL?, ROSC:SOUR?, OUTP:TONE:CONT? |
| 9 | MSCAN: Number of runs, synchronizing time, listening time, scan mode | MSC:COUN?, MSC:DWEL?, MSC:HOLD:TIME?, MSC:DIR?, MSC:CONT? |

| Bit No. | Set by change of: | Reset by query: |
|----------------|---|---|
| 10 | not used, always 0 (was used for DSCAN in EB200) | - |
| 12 | Frequency, demodulation, bandwidth, threshold value, antenna number, attenuation, squelch enable, AFC | MEM:CONT? 0 ... 1023 MEM: CONT: MPAR? 0 ... 1023 |
| 13 | Query bit: (set, reset). | MEM:CONT? 0 ... 1023 MEM: CONT: MPAR? 0 ... 1023 |
| 14 | PSCAN: Start frequency, stop frequency | FREQ:STAR?, FREQ:STOP? |

9.2.1.8 STATus:QUEStionable register

This register contains information on ambiguous device states. They can occur, for example if the device is operated outside its specification range. It can be queried using the commands STATus:QUEStionable:CONDition? or STATus:QUEStionable[:EVENT]?

Not all bits of this register are free for any use. Table 9 shows what bits have requirements.

Table 9: Bit allocation of STATus:QUEStionable register

| Bit No. | Meaning |
|----------------|---|
| 2 | BATTery low This bit is set if the supply (or battery) voltage becomes too low. |
| 4 | TEMPerature This bit is set if the internal temperature is too high. |

9.2.2 Use of the Status Reporting System

In order to be able to effectively use the status reporting system, the information contained there has to be transmitted to the host where it is further processed. There are several methods which are described in the following sub-sections.

9.2.2.1 Service request, making use of the hierarchy structure

Under certain circumstances, the device can send a "service request" (SRQ) to the host. As Section 0 shows, an SRQ is always initiated if one or several of the bits 0, 1, 2, 3, 4, 5 or 7 of the status byte are set and enabled in the SRE. Each of these bits combines the information of a further register, the error queue or the output buffer. By setting the ENABLE sections of the status registers correspondingly, it can be achieved that any bits in any status register initiate an SRQ. In order to use the service request, some bits should

be set to "1" in enable registers SRE and ESE. Only those bits need to be set that represent the situations for which a service request must be received.

Examples (also see Section 0):

Use command "*OPC" to generate an SRQ

- Set bit 0 in the ESE (Operation Complete)
- Set bit 5 in the SRE

After completion of the settings, the device generates an SRQ. For SCPI over TCP/IP, this is a text-response "&SRQ<CR><LF>", where <CR> is a carriage-return, and <LF> is a line-feed. A C-type string would read as: "&SRQ\r\n".

Indication of a signal during a sweep by means of an SRQ at the host

- Set bit 7 in the SRE (summary bit of the STATus:OPERation register)
- Set bit 3 (SWEeping) in the STATus:OPERation:ENABLE.
- Set bit 3 in the STATus:OPERation:NTRansition so that the change of SWEeping-bit 3 from 0 to 1 is also recorded in the EVENT section.
- Set bit 0 in STATus:OPERation:SWEeping:ENABLE
- Set bit 0 in STATus:OPERation:SWEeping:PTRansition so that the change of hold-bit 0 from 0 to 1 is also recorded in the EVENT section.

The device generates an SRQ after a signal has been found.

Once an SRQ has been received, the contents of the status-byte register can be polled. For SCPI over TCP/IP, polling is done by sending the string "&POL". The PR100 device then answers with the string "&<value><CR><LF>", where <value> is the decimal value of the contents of the STB.

The SRQ is the only possibility for the device to become active on its own.

Each host program should set the device so that a service request is initiated in case of malfunction. The program should react appropriately to the service request.

9.2.2.2 Query by means of commands

Each part of every status register can be read by means of queries. Only one number is returned which represents the bit pattern of the register queried.

The format of the number can be set by the FORMat:SREGister command.

Queries are usually used after an SRQ in order to obtain more detailed information on the cause of the SRQ.

9.2.2.3 Error-queue query

Each error state in the device results in an entry in the error queue. The entries of the error queue are detailed plain-text error messages which can be queried by the command SYSTem:ERRor?. Each call of SYSTem:ERRor? provides one entry from the error queue. If no error messages are stored there anymore, the device responds with 0, "No error".

The error queue should be queried after every SRQ in the controller program as the entries describe the cause of an error more precisely than the status registers. Especially during the test phase of a controller program the error queue should be queried regularly since faulty commands from the controller to the device are recorded there as well.

9.2.3 Resetting values of the status reporting system

Table 10 comprises the different commands and events causing the status reporting system to be reset. None of the commands, except for *RST, influences the functional device settings. In particular, DCL does not change the device settings.

Table 10: Resetting device functions. (1: the next command-line clears the output buffer, DCL: Device Clear, SDC Selected Device Clear)

| <i>Effect</i> | <i>Power On</i> | <i>DCL, SDC</i> | <i>*RST</i> | <i>STATus:PRESet</i> | <i>*CLS</i> |
|--|-----------------|-----------------|-------------|----------------------|-------------|
| <i>Clear STB, ESR</i> | yes | - | - | - | yes |
| <i>Clear SRE, ESE</i> | yes | - | - | - | - |
| <i>Clear PPE</i> | yes | - | - | - | - |
| <i>Clear EVENT sections of the registers</i> | yes | - | - | - | yes |
| <i>Clear ENABLE section of all OPERATION and QUESTIONABLE registers, Fill ENABLE sections of all other registers with "1".</i> | yes | - | - | yes | - |
| <i>Fill PTRansition sections with "1" , Clear NTRansition sections</i> | yes | - | - | yes | - |
| <i>Clear error queue</i> | yes | - | - | - | yes |
| <i>Clear output buffer</i> | yes | yes | 1 | 1 | 1 |
| <i>Clear command processing and input buffer</i> | yes | yes | - | - | yes |

9.3 Error Messages

The following list contains all error messages for errors occurring in the instrument. The meaning of negative error codes is defined in SCPI (Standard Commands for Programmable Instruments), positive error codes mark errors specific for the instrument.

In the left column the table contains the error text which is entered in the error/event queue. In the right column there is an explanation regarding the respective error.

For some errors, a so-called device-dependent info is added to the error message. It gives further information about the error source (eg. -222, "Data out of range", frequency too high).

Table 11: "No Error" message

| <i>Error code from queue query</i> | <i>Error explanation</i> |
|------------------------------------|--------------------------|
|------------------------------------|--------------------------|

| | |
|----------------------|--|
| 0, "No error" | This message is output if the error queue does not contain entries |
|----------------------|--|

Table 12: Command Error - Faulty command; sets bit 5 in the ESR register

| Error code from queue query | Error explanation |
|--|--|
| -100, "Command error" | The command is faulty or invalid. |
| -101, "Invalid character" | The command contains an invalid sign. Example: A command contains an ampersand, "SENSe &". |
| -102, "Syntax error" | The command is invalid. Example: The command contains block data the instrument does not accept. |
| -103, "Invalid separator" | The command contains an impermissible sign instead of a separator. Example: A semicolon is missing after the command. |
| -104, "Data type error" | The command contains an invalid value indication. Example: ON is indicated instead of a numeric value for frequency setting. |
| -105, "GET not allowed" | A Group Execute Trigger (GET) is within a command line. |
| -108, "Parameter not allowed" | The command contains too many parameters. Example: Command SENSe:FREQUENCY permits only one frequency indication. |
| -109, "Missing parameter" | The command contains too few parameters. Example: Command SENSe:FREQUENCY requires a frequency indication. |
| -111, "Header separator error" | The command contains an impermissible separator. Example: The header is not followed by a "White Space", "*ESE255" |
| -112, "Program mnemonic too long" | The command contains more than 12 characters. |
| -113, "Undefined header" | The command is not defined for the instrument. Example *XYZ is undefined for every instrument. |
| -114, "Header suffix out of range" | The command contains an impermissible numeric suffix. Example: SENSe9 does not exist in the instrument. |
| -121, "Invalid character in number" | A number contains an impermissible character. |
| -123, "Exponent too large" | The absolute value of the exponent is larger than 32000. |
| -124, "Too many digits" | The number contains too many digits. |

| <i>Error code from queue query</i> | <i>Error explanation</i> |
|--|--|
| <i>-128,"Numeric data not allowed"</i> | The command contains a number which is not allowed at this position. Example: Command FORMat:BORDER requires the indication of a text parameter. |
| <i>-131,"Invalid suffix"</i> | The suffix is invalid for this instrument. Example: nHz is not defined. |
| <i>-134,"Suffix too long"</i> | The suffix contains more than 12 digits. |
| <i>-138,"Suffix not allowed"</i> | A suffix is not allowed for this command or at this position of the command. |
| <i>-141,"Invalid character data"</i> | The text parameter either contains an invalid sign or it is invalid for this command. Example: spelling mistakes during parameter indication; FORMat:BORDER WASP |
| <i>-144,"Character data too long"</i> | The text parameter contains more than 12 characters. |
| <i>-148,"Character data not allowed"</i> | The text parameter is not allowed for this command or at this position of the command. |
| <i>-151,"Invalid string data"</i> | The command contains a faulty character string. Example: An End-of-Line (not a character but a flow-control) was received before the final quote character. |
| <i>-158,"String data not allowed"</i> | The command contains a valid character string at a position which is not allowed. Example: A text parameter is set in quotation marks, FORMat:BORDER "SWAP" |
| <i>-161,"Invalid block data"</i> | The command contains faulty block data. Example: An End-of-Line signal was received before the expected number of data had been received. |
| <i>-168,"Block data not allowed"</i> | The command contains valid block data at an impermissible position. |
| <i>-171,"Invalid expression"</i> | The command contains an impermissible mathematical expression. Example: The expression contains an uneven number of parentheses. |
| <i>-178,"Expression data not allowed"</i> | The command contains an expression at an impermissible position. |

Table 13: Execution Error - Error in executing the command; sets bit 4 in the ESR register

| <i>Error code from queue query</i> | <i>Error explanation</i> |
|---|---------------------------------|
|---|---------------------------------|

| Error code from queue query | Error explanation |
|---|---|
| -200, "Execution error" | Error during execution of the command. |
| -211, "Trigger Ignored" | A trigger is ignored when e.g. it occurs before the measuring time has elapsed. This can happen when the trigger time is smaller than the measuring time. |
| -221, "Settings conflict" | There is a settings conflict between two parameters. |
| -222, "Data out of range" | The parameter value is outside the permissible range of the instrument. |
| -223, "Too much data" | The command requires more storage for data than is available. E.g. A list of frequencies may only contain 5 elements, and the command tries to add a sixth. |
| -240, "Hardware error" | Hardware error is not further specified. |
| -241, "Hardware missing" | The command cannot be executed due to missing hardware. Example: An option is not installed. |
| -292, "Referenced name does not exist" | An unknown name was sent as a parameter. Example: An unknown file name is to be deleted, MMEM:RDIR "Flubber" |
| -293, "Referenced name already exists" | The name is defined twice. Example: An file already exists. |

Table 14: Device Specific Error; sets bit 3 in the ESR register

| Error code from queue query | Error explanation |
|--------------------------------------|---|
| -300, "Device-specific error" | Some data in memory not valid. |
| -350, "Queue overflow" | This error code is entered into the queue instead of the actual error code if the queue is full. It indicates that an error has occurred but not been accepted. The queue can accept 5 entries. |

Table 15: Query Error; sets bit 2 in the ESR register

| Error code from queue query | Error explanation |
|------------------------------------|--|
| -400, "Query error" | General error which is not further specified. |
| -410, "Query INTERRUPTED" | The query has been interrupted. Example: After a query, the instrument receives new data before the response has been sent completely. |
| -420, "Query" | The query is incomplete. Example: The |

UNTERMINATED"

instrument is addressed as a talker and receives incomplete data.

***-430, "Query
DEADLOCKED"***

The query cannot be processed. Example: The input and output buffers are full, the instrument cannot continue the operation.

Table 16: Device-dependent Error; sets bit 3 in the ESR register

| <i>Error code from queue query</i> | <i>Error explanation</i> |
|---|--|
| 1, "Device dependent error" | The error is not further specified. |
| 3, "Ethernet error" | Error in ethernet connection has been recognized. |
| 10, "Component failure" | A component indicates an error. |
| 20, "No free resources for action" | Indicates e.g. that a software buffer is full. |
| 200, "Temperature too high" | The internal temperature of the unit is too high. |
| 300, "Power fail" | One of the supply (or battery) voltage is too low. |

9.4 Commands Description

9.4.1 Notation

In the following sections, all commands implemented in the device are described in detail. The notation corresponds to the SCPI standard.

Indentations

The different levels of the SCPI command hierarchy are represented in the description by means of indentations to the right. The lower the level is, the further is the indentation to the right. Please observe that the complete notation of the command always includes the higher levels as well.

Example:

SENSE:FREQuency:STARt is indicated in the description as follows:

| | |
|---------------------|--------------|
| SENSe | first level |
| . :FREQuency | second level |
| . . :STARt | third level |

Upper-/Lower Case

Upper/lower-case letters serve to mark the long or short form of the key words of a command in the description (see next sections). The device itself does not distinguish between upper- and lower-case letters.

Special Characters

| - *Vertical Stroke*

A selection of keywords with an identical effect exists for some commands. These keywords are given in the same line and are separated by a vertical stroke. Only one of these keywords has to be indicated in the header of the command. The effect of the command is independent of the keywords being indicated.

Example:

SENSe

. :**BANDwidth**|:**BWIDth**

The two following commands of identical meaning can be formed. They set the frequency of the device to 123 MHz:

SENSe:BANDwidth 150E3 = SENSe:BWIDth 150E3

A vertical stroke in indicating the parameters marks alternative possibilities in the sense of "or". The effect of the command is different, depending on which parameter is entered.

Example: Selection of parameter for command

SENSe:GCONTRol:MODE FIXEd|MGC AUTO|AGC

If the parameter FIXEd is selected, the gain is determined by the MGC voltage. In case of AUTO the gain depends on the signal. The two parameters MGC and AGC are synonymous for FIXEd and AUTO.

[] – *Square Brackets*

Keywords in square brackets can be omitted in the command. The device also accepts the full command. Parameters in square brackets can also be optionally inserted into the command or can be omitted.

{ } – *Curly Braces*

Parameters in braces can be inserted in the command once or several times, or be omitted altogether.

9.4.2 Common Commands

The common commands are taken from the IEEE 488.2 (IEC 625-2) standard. A particular command has the same effect on different devices. The headers of these commands consist of an asterisk "*" followed by three letters. Many common commands concern the "status reporting system" in Section 9.

Table 17: Common Commands

| Command | Parameter | Query (also no only query) |
|---------|-----------|----------------------------|
| *CLS | | no query |
| *ESE | 0 ... 255 | also query |
| *ESR? | | only query |
| *IDN? | | only query |
| *IST? | | only query |
| *OPC | | also query |
| *OPT? | | only query |
| *PRE | 0 ... 255 | also query |
| *RST | | no query |
| *SRE | 0 ... 255 | also query |
| *STB? | | only query |

| | | |
|-------|--|------------|
| *TRG | | no query |
| *TST? | | only query |
| *WAI | | also query |

***CLS**

CLEAR STATUS sets the status byte (STB), the standard event register (ESR) and the EVENT sections of the QUESTIONABLE and the OPERATION register to zero. The command does not alter the mask and transition parts of the registers. It clears the output buffer.

***ESE 0 ... 255**

EVENT STATUS ENABLE sets the event status enable register to the value indicated. Query *ESE? returns the contents of the event status enable register in decimal form.

***ESR?**

STANDARD EVENT STATUS QUERY returns the contents of the event status register in decimal form (0 to 255) and subsequently sets the register to zero.

***IDN?**

IDENTIFICATION QUERY queries unit about identification. The output of the unit must be: "ROHDE&SCHWARZ, <model nr>, <serial nr>, <sw version>"

<model nr> is replaced by the model number of the device (e.g. PR100)
 <serial nr> is replaced by the serial number of the unit, format 123456/789
 <sw version> is replaced by the firmware version number, e.g. 1.03

***IST?**

INDIVIDUAL STATUS QUERY states the contents of the IST flags in decimal form (0 | 1).

***OPC**

OPERATION COMPLETE sets the bit in the event-status register to 0 if all previous commands were carried out. This bit can be used for triggering a service request.

***OPC?**

OPERATION COMPLETE QUERY writes the message '1' into the output buffer as soon as all previous commands were carried out.

***OPT?**

OPTION IDENTIFICATION QUERY queries about the options in the unit and outputs a list of installed options. The options are separated by a comma. The order in which the options are output can vary.

***PRE 0 ... 255**

PARALLEL-POLL REGISTER ENABLE sets parallel poll enable register to the value indicated. Query *PRE? returns the contents of the parallel poll enable register in decimal form.

***RST**

RESET sets the device to a defined default status. The default setting is indicated in the description of the commands.

***SRE 0 ... 255**

SERVICE REQUEST ENABLE sets the service request enable register to the value indicated. Bit 6 (MSS mask bit) remains 0. This command determines under which conditions a service request is triggered. Query *SRE? reads the contents of the service request enable register in decimal form. Bit 6 is always 0.

***STB?**

READ STATUS BYTE QUERY reads out the contents of the status byte in decimal form.

***TRG**

TRIGGER triggers the same actions as the INITiate:CONM[:IMMEDIATE] command.

***TST?**

SELFTTEST QUERY triggers the module state test and yields a figure which is to be interpreted as the bit field:

Result = 0

All modules are ok.

Result ≠ 0

There is a fault in one or several modules. The information about the possible error can be queried by means of the SYSTem:ERRor? Command.

***WAI**

WAIT-to-CONTINUE only permits the servicing of the subsequent commands after all preceding commands have been executed and all signals have settled.

10 Instrument Behaviour

The behaviour of the Orion MR is defined by the following aspects:

- Error Situations

There are several types of error situations that apply to a number of, otherwise unrelated, commands

- Ranging and Rounding

This applies to all commands that set a value. Ideally, the user supplies a value that is within the instrument's range and corresponds with its resolution. When this ideal situation is not met, ranging and rounding must be applied to get a value the instrument can handle.

- **Value Representation**
This applies to all commands that return a value. This value must be presented to the user with an adequate accuracy.
- **Default Values**
Each parameter that can be set or queried via SCPI has a default value after applying the *RST command.
- **Instrument States**
The behaviour of a command may vary between instrument states

10.1 Error Situations

The common behaviour of the instrument in error situations is as shown in the list below (unless other behaviour has been explicitly specified for a specific command or query):

- Do a command or query in an instrument state in which the command/query is not supported
The error -221 “Settings conflict” is returned
- Set a parameter to such a state that it conflicts with other parameters
The error -221 “Settings conflict” is returned. The device does not adapt other parameters in order to try to resolve a settings conflict. The new parameter setting is rejected and the device setup remains unchanged.
- Query a measurement result that is not available
SCPI outputs NAN instead of a value acc. to SCPI standard Section 7.2.1. Note that NAN is output as 9.91E37, as is also described in [SCPI] and [Orion SCPI].

Differences with EB200/EM050 Devices:

- A similar error situation may produce a different error code and message on the Orion MR and on the EB200/EM050.

10.2 Ranging and Rounding

Each parameter of the device that takes a value has a maximum and a minimum. In addition, each parameter has a resolution. The approach for setting a value for a parameter is as follows:

- if the supplied value is beyond its maximum or below its minimum, return error -222 “Data out of range” without changing the parameter. The device does not adapt other parameters in order to try to resolve a data out of range situation. The new parameter setting is rejected and the device setup remains unchanged.
- round the supplied value to the device’s resolution. For specific parameters (e.g. bandwidth), Orion can choose to round up or down instead of rounding towards the closest value.
- if the supplied value results in an error situation, return an error appropriate for that situation without changing the parameter.

- accept the rounded value.

Differences with EB200/EM050 Devices:

- The EB200 operates as described above, but does rounding before the range checking. That means that a value that is out of range, but within the resolution of the minimum or maximum, is accepted.

10.3 Value Representation

When a value (from either a measurement or from a setting) is presented to the user by means of a response to an SCPI query, it is presented with the accuracy that is used by the instrument. Exceptions to this rule will be documented.

10.4 Default Values

The device has only one set of default values: That means that both the user interface and the remote interface (SCPI) use the same default values for parameters. This is identical to the EB200/EM050 devices.

The EB200 and the Orion MR do not use the same set of default parameters and their values are not the same either.

10.5 Instrument States

10.5.1 Introduction

In order to get a good overview of how the Orion MR reacts to SCPI commands, one should study the various instrument states the device can have. These states dictate if an SCPI command is rejected or allowed. When a command is allowed, two situations can be distinguished:

- the command triggers a state transition and executes from there
- the command executes in the current state

This section describes the instrument states and shows the commands that trigger state transitions. A full description of these commands is part of the subsequent chapters. Each command is assigned to one or more states in which it can execute.

10.5.2 MR States

The various states of the Orion MR are depicted below:

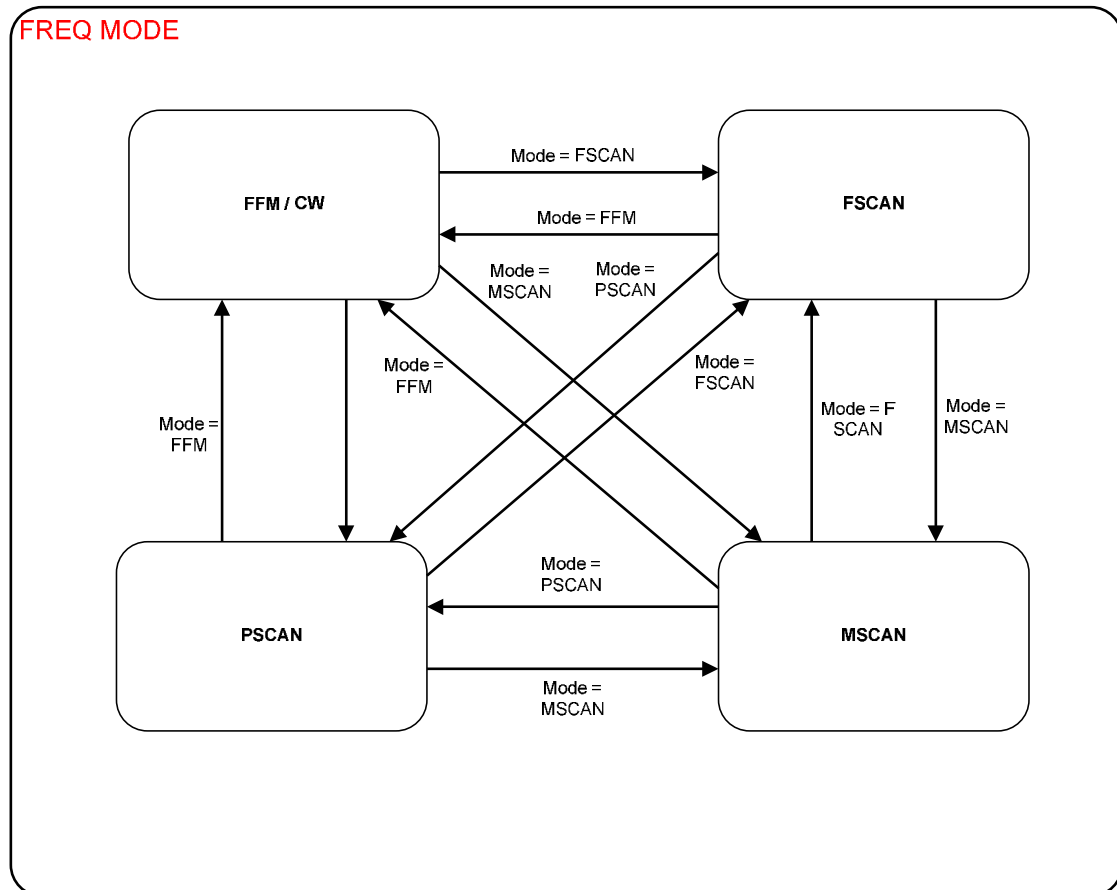

10.5.2.1 Fixed Frequency Mode (FFM/CW)

FFM is short for Fixed Frequency Mode. The modes correspond exactly to those of the SCPI command
Fixed Frequency Mode uses a single running state.

10.5.2.2 Frequency Scan Mode FSCAN

SENS:FREQ:MODE. In both Fscan and Mscan mode, the device has several substates that are shown in the Figure below:

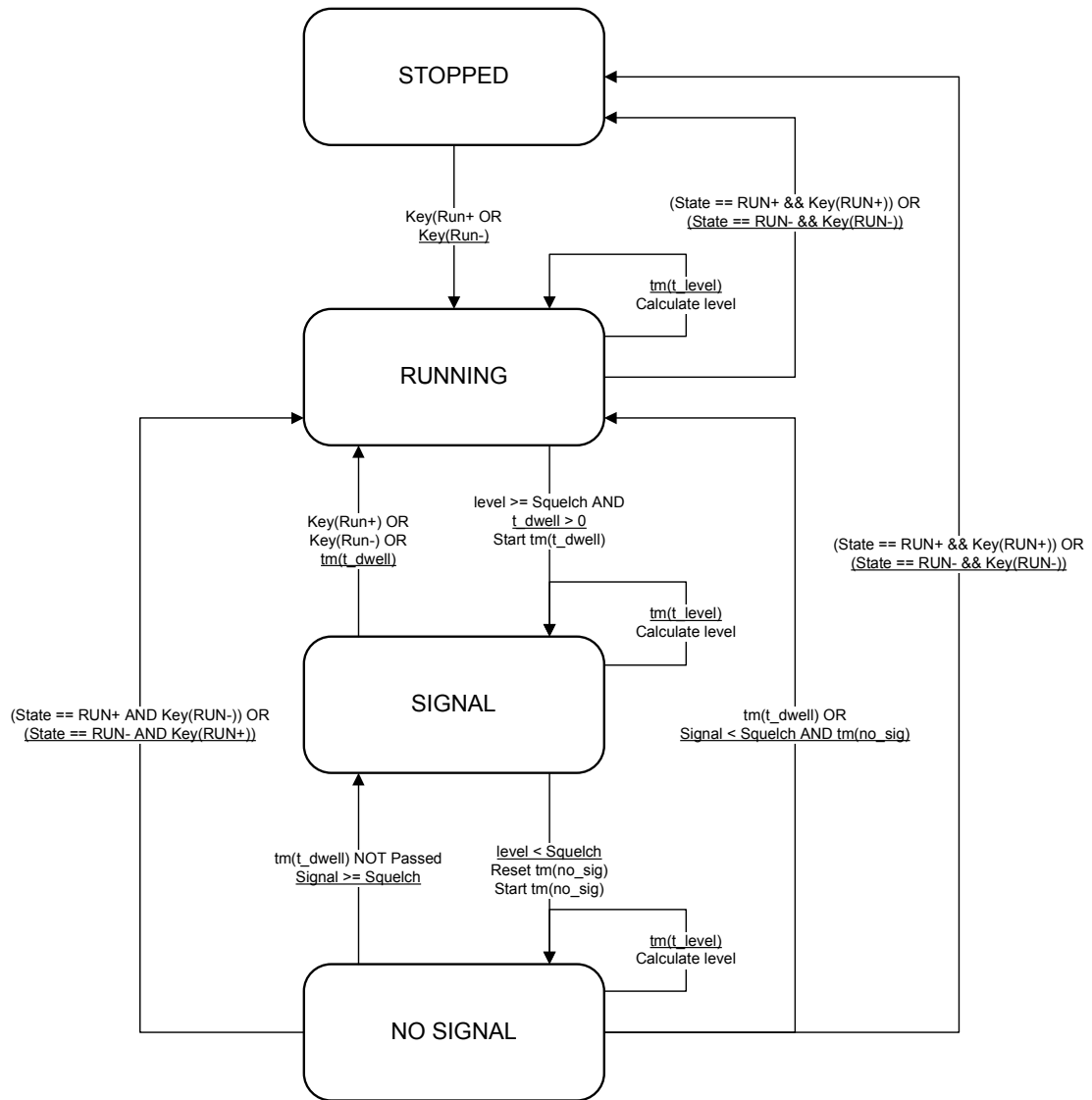

Figure 4 Frequency Scan Mode States

10.5.2.3 Memory Scan Mode MSCAN

Memory Scan Mode shows exactly the same behaviour as the Frequency Scan Mode in the way of internal states as presented in Figure 4.

10.5.2.4 Panorama Scan Mode PSCAN

In Panorama Scan Mode only states Stopped and Running are applicable.

11 Commands Reference

This chapter describes the SCPI commands that are specific to the Orion MR product. They are additional to the list in Chapter 4 of [Orion SCPI].

11.1 Common Commands

The commands listed in this section are taken from the IEEE 488.2 (IEC 625-2) standard and are supported by all instruments. However each instrument type may respond differently, e.g. the option query command returns all installed options which might be instrument specific.

*OPT?

OPTION IDENTIFICATION QUERY queries about the options in the unit and outputs a list of installed options. The options are separated by a comma. The returned optionlist is fixed and options which are not installed have a value equal to zero. Installed options are indicated by having the abbreviation used in the optionlist below:

| | |
|---------------------------|----|
| Panorama Scan | PS |
| Remote Control | RC |
| Fieldstrength Measurement | FS |

Example:

*OPT? returned PS,0,RC,0,FS,0,0

This instrument has the following options installed:

- Panorama Scan
- Reserved
- Remote Control
- Reserved
- Fieldstrength Measurement
- Reserved
- Reserved

11.2 *ABORt subsystem*

ABORt

Stop command for scans. This command stops an active scan and is the counterpart of INIT:IMM.

Parameters:

none

Example:

ABORt

11.3 *CALCulate subsystem*

CALCulate

```
. :IFPan
. . :AVERAge
. . . :TYPE MINimum|MAXimum|SCALar|OFF
```

Setting of the averaging procedure for the IF-panorama data.

Parameters:

| | |
|---------|---|
| MINimum | Keep minimum value of obtained measurements |
| MAXimum | Keep maximum value of obtained measurements |
| SCALar | Average measurements according to a device specific algorithm |
| OFF | Do not process obtained measurements |

Example:

CALCulate:IFPan:AVERAge:TYPE MINimum

CALCulate

```
. :IFPan
. . :AVERAge
. . . :TYPE?
```

Query of the averaging procedure for the IF-panorama data.

Result:

MIN, MAX, SCAL, OFF

Example:

CALCulate:IFPan:AVERAge:TYPE? -> MIN

CALCulate

. :IFPan
. . :CLEar

Restart of the averaging function for the IF-panorama data. The value obtained from IF-panorama measurements thus far is deleted, and a new value is obtained.

Parameters:

none

Example:

CALCulate:IFPan:CLEar

CALCulate

. :IFPan
. . :MARKer:MAXimum[:PEAK]

Centering of the IF-panorama spectrum to the absolute-level maximum. This changes the receiver frequency SENS:FREQ:CW.

Parameters:

none

Example:

CALCulate:IFPan:MARKer:MAXimum

CALCulate:IFPan:MARKer:MAXimum

**CALCulate**

```
. :IFPan
. . :MARKer:MAXimum:LEFT
```

The center of the IF-panorama spectrum is moved toward the nearest maximum on the left. This changes the receiver frequency SENS:FREQ:CW.

Parameters:

none

Example:

```
CALCulate:IFPan:MARKer:LEFT
```

**CALCulate**

```
. :IFPan
. . :MARKer:MAXimum:RIGHT
```

The center of the IF-panorama spectrum is moved toward the nearest maximum on the right. This changes the receiver frequency SENS:FREQ:CW.

Parameters:

none

Example:

```
CALCulate:IFPan:MARKer:RIGHT
```

**CALCulate**

```
. :PSCan
. . :AVERage
. . . :TYPE MINimum|MAXimum|SCALar| OFF
```

Setting of the averaging procedure for the panorama-scan data. Each FFT sample is processed separately, e.g. for the MAXimum type a maximum value is kept for each bin in a panorama scan.

Parameters:

| | |
|---------|--|
| MINimum | Keep minimum value of obtained measurements |
| MAXimum | Keep maximum value of obtained measurements |
| SCALar | Average measurements over the measurement time |
| OFF | Do not process obtained measurements |

Example:

```
CALCulate:PSCan:AVERage:TYPE MINimum
```

**CALCulate**

```
. :PSCan
. . :AVERage
. . . :TYPE?
```

Query of the averaging procedure for the panorama-scan data.

Result:

MIN, MAX, SCAL, OFF

Example:

```
CALCulate:PSCan:AVERage:TYPE? -> MIN
```

**CALCulate**

. :PSCan
. . :CLEar

Restart of the averaging function for the panorama-scan data. The values for each bin in the FFTs measured thus far are deleted, and new values are obtained.

Parameters:

none

Example:

CALCulate:PSCan:CLEar

**CALCulate**

. :PSCan
. . :MARKer:MAXimum[:PEAK]

Moves the receiver frequency to the FFT-bin with the absolute-level maximum in the RF panorama. This changes the receiver frequency SENS:FREQ:CW

Parameters:

none

Example:

CALCulate:PSCan:MARKer:MAXimum



CALCulate

- . :PSCan
- . . :MARKer:MAXimum:LEFT

Moves the receiver frequency to the maximum that lies to the left of the current frequency in the RF-panorama scan. This changes the receiver frequency SENS:FREQ:CW. If squelch is on, only the maxima that are above the squelch level are taken into account.

Parameters:

none

Example:

CALCulate:PSCan:MARKer:LEFT



CALCulate

- . :PSCan
- . . :MARKer:MAXimum:RIGHT

Moves the receiver frequency to the maximum that lies to the right of the current frequency in the RF-panorama scan. This changes the receiver frequency SENS:FREQ:CW. If squelch is on, only the maxima that are above the squelch level are taken into account.

Parameters:

none

Example:

CALCulate:PSCan:MARKer:RIGHT

11.4 DIAGnostic subsystem

DIAGnostic

- . [:SERVice]
- . . :ADAPter
- . . . [:STATe]?

Query whether the instrument is currently being powered by a mains adapter.

Result:

- 0 Instrument is powered by internal battery.
- 1 Instrument is powered by mains adapter.

Example:

DIAGnostic:ADAPter? -> 1



DIAGnostic

. [:SERvice]
 . . :INFO
 . . . :SVERsion?

Query of the software version.

Parameters:

none

Result:

Software version

Example:

DIAGnostic:INFO:SVERsion? -> V[12.34]

“V” indicates this is a release version, “B” is for beta versions

12 is the major version number

24 is the minor version num

11.5 DISPlay subsystem**DISPlay**

. :BRIGhtness <numeric_value>|MINimum|MAXimum

Controls the brightness of the display backlighting.

Parameters:

<numeric_value> brightness of backlighting from 0.00 to 1.00

0.00 = backlighting off

1.00 = full backlighting

MINimum|MAXimum backlighting off|full backlighting

Remark:

The brightness can be set between 0.00 and 1.00 with 2 decimals resolution.

Example:

DISPlay:BRIGhtness 0.45

DISPlay

. :BRIGhtness? [MINimum|MAXimum]

Query of brightness of display backlighting.

Parameter:

none query of current brightness

MINimum|MAXimum query of lowest|highest brightness

Result:

Brightness of backlighting from 0.00 to 1.00

Example:

DISPlay:BRIGhtness? -> 0.45

**DISPlay**

. :C**MAP:DEFault**

Selection of display-colors for indoor use.

Parameters:

none

Example:

DISPlay:C**MAP:DEFault**

**DISPlay**

. :C**MAP INDOor|OUTDOor|BW**

Selection of display color-scheme.

Parameters:

| | |
|---------|------------------------------|
| INDoor | Color-scheme for indoor use |
| OUTDoor | Color-scheme for outdoor use |
| BW | Black and White color-scheme |

Example:

DISPlay:C**MAP OUTDOor**

**DISPlay**

. :C**MAP?**

Query of the currently selected color-scheme.

Parameters:

none

Result:

IND, OUTD, BW

Example:

DISPlay:C**MAP? -> OUTD**

DISPlay

- . :DATE
- . . :FORMat DDMMyyyy|MMDDyyyy

Sets the date format used for display

Parameters:

DDMMyyyy E.g. 31/12/2005

MMDDyyyy E.g. 12/31/2005

Example:

DISPlay:DATE:FORMat MMDDyyyy

DISPlay

- . :DATE
- . . :FORMat?

Query the date format used for display

Parameter:

none

Result:

DDMM, MMDD

Example:

DISPlay:DATE:FORMat? -> MMDD

**DISPlay**

. :FSTRength <Boolean>

Enable or disable the display of field strength information. Note that the information can only be shown if a valid K-factor has been set.

Parameters:

ON enable field-strength display

OFF disable field-strength display

Example:

DISPlay:FSTRength OFF

**DISPlay****. :FSTRength?**

Query whether field-strength is displayed or not

Parameters:

none

Result:

0 OFF

1 ON

Example:

DISPlay:FSTRength? -> 0

**DISPlay****. :IFPan****. . :LEVel****. . . :RANGe <numeric_value>|MINimum|MAXimum**

Sets the range of signal levels that is displayed in a panorama view. Different levels within this range can be distinguished in the view. The top-end of the range is equal to "DISP:IFP:LEV:REF".

Parameters:

<numeric_value> signal-level range in dB μ V

MINimum|MAXimum minimum|maximum range

Example:

DISPlay:IFPan:LEVel:RANGe 30



DISPlay

```
. :IFPan
. . :LEVel
. . . :RANGe? [MINimum|MAXimum]
```

Query the range of signal levels that is displayed in an IFPan view

Parameter:

none query of current range
 MINimum|MAXimum query of minimum|maximum range

Result:

signal-level range in dB μ V

Example:

DISPlay:IFPan:LEVel:RANGe? -> 30



DISPlay

```
. :IFPan
. . :LEVel
. . . :REFerence <numeric_value>|MINimum|MAXimum
```

Sets the maximum signal-level that can be displayed in an IFPan view.

Parameters:

<numeric_value> reference level in dB μ V
 MINimum|MAXimum lowest|highest reference level

Example:

DISPlay:IFPan:LEVel:REFerence 40



DISPlay

. :IFPan
 . . :LEVel
 . . . :REFerence? [MINimum|MAXimum]

Query of maximum signal-level that can be displayed in an IFPan view

Parameter:

none query of current reference level
 MINimum|MAXimum query of lowest|highest reference level

Result:

reference level in dB μ V

Example:

DISPlay:IFPan:LEVel:REFerence? -> 40



DISPlay

. :LEVel
 . . :LIMit
 . . . :MINimum <numeric_value>|MINimum|MAXimum

Sets the lower limit for the level-bar display. Signal-level with lower values cannot be distinguished (i.e. are displayed with the same size of level bar). This setting only applies if the tone mode is off (OUTP:TONE:STAT OFF). If tone mode is on, the device determines the lower limit itself.

Parameters:

<numeric_value> signal-level in dB μ V
 MINimum|MAXimum lowest|highest signal-level

Example:

DISPlay:LEVel:LIMit:MINimum 20



DISPlay

- . :LEVel
- . . :LIMit
- . . . :MINimum? [MINimum|MAXimum]

Query of lower limit for the level-bar display

This setting only applies if the tone mode is off (OUTP:TONE:STAT OFF). If tone mode is on, the device determines the lower limit itself.

Parameter:

none query of current signal-level in dB μ V
 MINimum|MAXimum query of lowest|highest signal-level

Result:

signal-level in dB μ V

Example:

DISPlay:LEVel:LIMit:MINimum? -> 20



DISPlay

- . :LEVel
- . . :RANGe <numeric_value>|MINimum|MAXimum

Sets the range of signal levels that is displayed in a level-bar view. Different levels within this range can be distinguished in the panorama view. The top-end of the range is equal to "DISP:LEV:LIM:MIN".

This setting only applies if the tone mode is off (OUTP:TONE:STAT OFF). If tone mode is on, the device determines the lower limit itself.

Parameters:

<numeric_value> signal-level range in dB μ V
 MINimum|MAXimum minimum|maximum range

Remark:

The range can be set in discrete steps. Intermediate values are therefore rounded to the nearest discrete value.

Example:

DISPlay:LEVel:RANGe 30



DISPlay

- . :LEVel
- . . :RANGe? [MINimum|MAXimum]

Query range of signal levels that is displayed in a level-bar view
 This setting only applies if the tone mode is off (OUTP:TONE:STAT OFF). If tone mode is on, the device determines the lower limit itself.

Parameter:

none query of current range
 MINimum|MAXimum query of minimum|maximum range

Result:

signal-level range in dB μ V

Example:

DISPlay:LEVel:RANGe? -> 30



DISPlay

- . :PSCan
- . . :LEVel
- . . . :RANGe <numeric_value>|MINimum|MAXimum

Sets the range of signal levels that is displayed in a panorama view. Different levels within this range can be distinguished in the view. The top-end of the range is equal to "DISP:PSCAN:LEV:REF".

Parameters:

<numeric_value> signal-level range in dB μ V
 MINimum|MAXimum minimum|maximum range

Example:

DISPlay:PSCAN:LEVel:RANGe 30



DISPlay

. :PSCan
 . . :LEVel
 . . . :RANGe? [MINimum|MAXimum]

Query the range of signal levels that is displayed in a panorama view

Parameter:

none query of current range
 MINimum|MAXimum query of minimum|maximum range

Result:

signal-level range in dB μ V

Example:

DISPlay:PSCAN:LEVel:RANGe? -> 30



DISPlay

. :PSCan
 . . :LEVel
 . . . :REFerence <numeric_value>|MINimum|MAXimum

Sets the maximum signal-level that can be displayed in a panorama view.

Parameters:

<numeric_value> reference level in dB μ V
 MINimum|MAXimum lowest|highest reference level

Example:

DISPlay:PSCAN:LEVel:REFerence 40



DISPlay

. :PSCan
 . . :LEVel
 . . . :REFerence? [MINimum|MAXimum]

Query of maximum signal-level that can be displayed in a panorama view

Parameter:

none query of current reference level
 MINimum|MAXimum query of lowest|highest reference level

Result:

reference level in dB μ V

Example:

DISPlay:PSCAN:LEVel:REFerence? -> 40



DISPlay

. :WATERfall
 . . :CMAP <color map>

Sets the color map that is used for converting signal-levels to colors in the waterfall display. Possible color maps can be retrieved with "DISP:WAT:CMAP:CAT?".

Parameters:

<color map> string with the name of the color map.
 Note that the full string must be provided, no SCPI-like abbreviation applies here.

Example:

DISPlay:CMAP "Black-White"

**DISPlay**

. :WATerfall
. . :CMAp?

Query the current color map for waterfall display

Parameter:

none

Result:

string with the name of the color map

Example:

DISPlay:CMAp? -> "Black-White"

**DISPlay**

. :WATerfall
. . :CMAp
. . . :CATalog?

Produces a list of all available color maps as a comma separated list

Parameter:

none

Result:

comma separated list of color maps

Example:

DISPlay:CMAp? -> "Default","Green-Yellow","Green-Blue","Black-White","Red-Purple"," Blue-Black"



DISPlay

```
. :WATerfall
. . :CMAP
. . . :RANGe <numeric_value>|MINimum|MAXimum
```

Determines the signal-level range over which distinguishing colors are assigned to different signal levels. The range starts at the threshold (DISP:WAT:CMAP:THR) as the lower end of the range.

Parameters:

<numeric_value> range in dB μ V
 MINimum|MAXimum lowest|highest setting for the range

Example:

```
DISPlay:WATerfall:CMAP:RANGe 30
```



DISPlay

```
. :WATerfall
. . :CMAP
. . . :RANGe? [MINimum|MAXimum]
```

Query of signal-level range for color coding in waterfall display

Parameter:

none query of current range in dB μ V
 MINimum|MAXimum query of lowest|highest range setting

Result:

range in dB μ V

Example:

```
DISPlay:WATerfall:CMAP:RANGe? -> 30
```



DISPlay

. :WATerfall

. . :CMAp

. . . :THReshold <numeric_value>|MINimum|MAXimum

Signal levels below this threshold all get the same background color in the waterfall display. I.e. no distinguishing color is assigned to different signal levels below the threshold.

Parameters:

<numeric_value> threshold in dB μ V

MINimum|MAXimum lowest|highest setting for the threshold

Example:

DISPlay:WATerfall:CMAp:THR 20



DISPlay

. :WATerfall

. . :CMAp

. . . :THReshold? [MINimum|MAXimum]

Query of signal threshold for color coding in waterfall display

Parameter:

none current threshold in dB μ V

MINimum|MAXimum query of lowest|highest setting for the threshold

Result:

threshold in dB μ V

Example:

DISPlay:WATerfall:CMAp:THR? -> 20

**DISPlay**

- . :WATERfall
- . . :HOLD
- . . . [:STAtE] <Boolean >

Freezes the waterfall. When the state is OFF, the waterfall is frozen. In case the state is ON, the waterfall runs again.

Parameters:

- ON waterfall runs
- OFF waterfall is frozen

Example:

DISPlay:WATERfall:HOLD ON

**DISPlay**

- . :WATERfall
- . . :HOLD
- . . . [:STAtE]?

Query of the waterfall state.

Parameter:

none

Result:

0, 1

Example:

DISPlay:WATERfall:HOLD? -> 1

**DISPlay**

. :WATerfall

. . :SPEEd <numeric_value>|MINimum|MAXimum

Controls the speed of the waterfall display.

Parameters:

<numeric_value> number of lines per second

MINimum|MAXimum slowest|fastest speed

Example:

DISPlay:WATerfall:SPEEd 10

**DISPlay**

. :WATerfall

. . :SPEEd? [MINimum|MAXimum]

Query of speed of the waterfall display.

Parameter:

none query of current brightness

MINimum|MAXimum query of lowest|highest speed

Result:

lines per second

Example:

DISPlay:WATerfall:SPEEd? -> 10

**DISPlay**

. :WINDow <display>

Controls what is displayed. In case a window is chosen that is incompatible with the current scan mode (see SENS:FREQ:MODE), an error is generated: -221, "Settings conflict", and no change is made. In case the MR is put into a mode that is incompatible with the currently selected display mode, the display mode defaults to "RX + Spectrum".

Parameters:

display See "DISP:WIND:CAT?" for a list of possible displays

Example:

DISPlay:WINDow "RX + Spectrum"

**DISPlay**

. :WINDow?

Query of current display

Parameter:

none

Result:

See "DISP:WIND:CAT?"

Example:

DISPlay:WINDow? -> "RX + Spectrum"



DISPlay

. :WINDow

. . :CATalog?

Query of available displays.

Parameter:

none

Result:

“RX Only” Receive information in whole screen (not possible with PSCAN scan mode)

“RX + Spectrum” Receive information in upper part and spectrum in lower part of screen

“Spectrum” Spectrum in whole screen

“Spectrum + Waterfall” Spectrum in upper part and waterfall in lower part of screen

“Waterfall” Waterfall in whole screen

“Dual Spectrum” Dual spectrum: IFPan spectrum in upper part and PSCAN spectrum in lower part

(not possible with Memory and Frequency scan modes)

Example:

DISPlay:WINDow:CATalog? -> ... (See under Result)

DISPlay

. :WINDow

. . :FETCh?

Creates a screen dump of the display in PNG format and outputs it as block data

Parameters:

none

Example:

DISPlay:WINDow:FETCh? -> Block data of PNG picture.

DISPlay

- . :WINDow
- . . :STORE <file name>

Creates a screen dump of the display in PNG format and stores it in a file on storage card with the name <file name>.

Parameters:

file name Name and path of file to store the screen dump in.

***RST state:**

None, as command is an event.

Example:

DISPlay:WINDow:STORE "screen.png" -> Creates "screen.png"

11.6 FORMat subsystem

Each individual client specifies it's own format meaning that different formats may be present at the same time between multiple clients.

FORMat

- . :BORDER NORMAL|SWAPped

Specifies whether numbers in binary data are sent with the least or most significant byte first. Binary data are data that are not in ASCII format, but in PACKed format as can be specified with the command FORMat:DATA.

Parameters:

NORMAL MSB first, LSB last

SWAPped LSB first, MSB last

Example:

FORMat:BORDER SWAPped

FORMat

- . :BORDER?

Query of output order for binary data.

Parameters:

none

Result:

NORM, SWAP

Result:

FORMat:BORDER? -> SWAP

FORMat

. **[[:DATA] ASCii|PACKed [, length]**

Specifies the output format of queries that output measurement data. The length parameter is currently only used for the ASCii setting. In this case, a length larger than zero determines the number of significant digits to be returned. When length is zero, the number of digits is determined by the device itself.

Parameters:

ASCii output in ASCII format according to SCPI standard.
PACKed output in Orion binary format
Length Number of significant digits to be returned

Example:

FORMat PACKed

FORMat

. **[[:DATA]?**

Query of output format of the queries mentioned under the FORM:DATA command.

Parameters:

none

Result:

ASC, PACK

Example:

FORMat? -> PACK

FORMat

. **:MEMory ASCii|PACKed**

Specifies the output format of the query:
MEMory:CONTents?

Parameters:

ASCii output in ASCII format according to SCPI standard.
PACKed output in device specific binary format

Remark:

See the description of the above query for a specification of its device specific binary format.

Example:

FORMat:MEMory PACKed

FORMat

. :MEMory?

Query of output format of the queries mentioned under the FORM:MEM command.

Parameters:

none

Result:

ASC, PACK

Example:

FORMat:MEMory? -> PACK

FORMat

. :SREGister ASCII|BINary|HEXadecimal|OCTal

Specifies with which data format is used for the queries of all CONDition, EVENT, ENABLE, PTRansition, NTRansition registers and all IEEE-488.2 status registers.

Parameters:

ASCIi output as decimal figure in ASCII code (e.g. 128)
 BINary output as binary figure in ASCII code (e.g. #B10000000)
 HEXadecimal output as hexadecimal figure in ASCII code (e.g. #H80)
 OCTal output as octal figure in ASCII code (eg #Q200)

Remark:

Note that a "Q" is used as prefix for octal numbers and not an "O" to avoid confusion with the digit 0 (zero).

Example:

FORMat:SREGister HEXadecimal

FORMat

. :SREGister?

Query of output format of the queries mentioned under the FORM:SREG command.

Parameters:

none

Result:

ASC, BIN, HEX, OCT

Example:

FORMat:SREGister? -> HEX

11.7 INITiate subsystem**INITiate**

. [:IMMEDIATE]

The INITiate command is an event which starts an acquisition or measurement if the instrument mode is set to fixed frequency mode, CW, or the scanner if one of the scanner modes is active. An active scan is restarted if it was already started.

Parameters:

None

Remark:

All M-trace, I-trace and IFPan-trace buffers are cleared after executing an INITiate command. Only the first measurement value is stored in the trace-buffers when the measurement mode is set to continuous. Values will be added until the trace-buffer is full when the mode equals periodic

Example:

INITiate

INITiate

. :CONM
. . [:IMMediate]

The INITiate CONTinue Measurement is identical to the INITiate command described in the previous section except for the fact that trace buffers are not cleared and an active scan is not restarted. Using the CONTinue Measurement form appends new measurement values to the current values present in the trace buffers. Using this command when a scanner causes the scanner to select the next frequency in frequency scan mode or the next memory channel when the memory scanner is active.

Parameters:

None

Remark:

The INITate CONTinue Measurement command has no effect when the measurement mode is set to periodic.

Example:

INITiate:CONM

11.8 INPut subsystem

INPut

- . :ATTenuation
- . . :STATe <Boolean>

Switch on/off of input attenuator.

Parameters:

ON attenuator on
OFF attenuator off

Example:

INPut:ATTenuation:STATe ON

INPut

- . :ATTenuation
- . . :STATe?

Query of the input attenuator setting.

Parameters:

none

Result:

0 OFF
1 ON

Example:

INPut:ATTenuation:STATe? -> 1

11.9 MEASure subsystem

MEASure

. :MODE CONTInuous|PERiodic

In the **PERiodic** measurement mode all detectors are discharged after the measurement time has elapsed and the next measurement is started. Only the individual measured values per measuring period are displayed.

In the **CONTInuous** measuring mode the measuring detector is read out every 200 ms, irrespective of the measuring time. These current measured values are displayed.

Remark:

Parameters:

CONTInuous continuous measurement
PERiodic periodic measurement

Example:

MEASure:MODE PERiodic

MEASure

. :MODE?

Query of the set measuring mode.

Parameters:

none

Result:

CONT, PER

Example:

MEASure:MODE? -> PER

MEASure

. :TIME <numeric_value>|MINimum|MAXimum|DEFault

Setting of the measuring time for all measuring functions.

Remark:

The measuring time has an effect on the level detectors. When the level mode is set to average, AVG, the measuring time determines the averaging time. When set to peak, PEAK, this time determines the fall time. Using fast as level method does not have any impact since it is only the current value which is measured.

The measuring time also has an impact on the averaging time of the IF-panorama data.

Parameters:

<numeric_value> measuring time in seconds
MINimum|MAXimum shortest/longest measuring time
DEFault use preset measuring times

Example:

MEASure:TIME 50 ms
MEASure:TIME DEF

MEASure

. :TIME? [MINimum|MAXimum]

Query of the set measuring time

Parameters:

none query of the current measuring time
MINimum|MAXimum query of the shortest/longest measuring time

Result:

Measuring time in seconds; with the default measuring time being set, DEF will be output.

Example:

MEASure:TIME? -> 0.050000
MEASure:TIME? -> DEF

11.10 MEMory subsystem

This subsystem contains all the functions necessary to operate the device's memory locations. A Memory location can be addressed in the following ways:

CURRENT the currently selected memory location
 0 ... 1023 memory location 0 to memory location 1023
 NEXT the next free memory location, starting from and including
 the current location
 RX the current receiver settings

Not all of these addressing options are allowed for every memory command. Those that are allowed are specified. Note that the currently active memory location can be queried by the "MSCAN:CHAN?" command.

MEMory

. :CLEar <mem_loc> [,<count>|MAXimum]

Clearing the contents of a single memory location or a range of memory locations.

Parameters:

<mem_loc> CURRENT|0...1023
 <count> number of memory locations to be cleared, starting from
 memory location <mem_loc>
 As a default value, <count> = 1.
 MAXimum clearing all memory locations following and including
 <mem_loc>

Example:

MEMory:CLEar 123

MEMory

- . :CONFig
- . . :CATalog?

Outputs the name of the memory configuration. This name can only be modified by uploading another configuration via the MEMory:CONFig command.

Parameter:

none

Result:

Name of memory configuration file, in a format identical to that of MMEM:CAT? (see [Orion SCPI]).

Example:

```
MEMory:CONFig:CATalog? -> 3000, 120000000 SomeConfigurationName,  
.memlst, 1000, 14-12-2006, 19:05:03
```

MEMory

- . :CONFig <block_data>

Upload and activate a configuration for memory locations.

Parameters:

<block_data> block data with memory configuration

Example:

```
MEMory:CONFig <block-data specific for memory configuration>
```

MEMory**. : CONFig?**

Outputs the configuration of the memory locations as block data.

Parameters:

none

Result:

<block_data> of file contents

Example:

MEMory:CONFig? -> <block-data specific for memory configuration>

MEMory

. :CONTents <mem_loc>, <mem_paras>|<packed_struct>

Loading a memory location. The memory contents can be specified in two ways:

<mem_paras> A comma-separated list of parameters in a specific order.
 <packed_struct> A device specific binary format, provided as a Block Data.

Parameters:

<mem_loc> CURRENT|0...1023|NEXT|RX
 <mem_paras> <F>, <THR>, <DEM>, <BW>, <ANT>, <ATT>, <ATTA>, <SQUC>, <AFC>, <ACT>
 <packed_struct> Block Data with the following payload

The definition of the parameters is as follows:

| Parameter | C Data-Type | Description |
|-----------|--------------------|--|
| <F> | unsigned long long | frequency in Hz (see SENS:FREQ:CW). Note that a “long” type is not large enough, since frequencies can be larger than 4 GHz. |
| <THR> | signed short | squelch threshold in dB μ V (see OUTP:SQU:THR) |
| <DEM> | unsigned short | type of demodulation (see SENS:DEM) packed_struct: See Table 24 in Section 12.2 |
| <BW> | unsigned long | Bandwidth in Hz (see SENS:BWID). |
| <ANT> | unsigned char | antenna number (see ROUT:SEL) packed_struct: 0...99 |
| <ATT> | unsigned char | attenuator (see INP:ATT:STAT) packed_struct: 0 = OFF, 1 = ON |
| <ATTA> | unsigned char | Always 0 = OFF. This field was kept for compatibility with EB200. |
| <SQUC> | unsigned char | squelch function (see OUTP:SQU:STAT) packed_struct: 0 = OFF, 1 = ON |
| <AFC> | unsigned char | AFC function (see (SENS:FREQ:CW:AFC) packed_struct: 0 = OFF, 1 = ON |
| <ACT> | unsigned char | include the memory in a memory scan packed_struct: 0 = OFF, 1 = ON |

The block data is a structure that is defined as follows:

| 32-bit aligned | 8-bit aligned | 16-bit aligned | 8-bit aligned |
|----------------|---------------|----------------|---------------|
| <F> (8 bytes) | | | |
| <THR> | | <DEM> | |
| <BW> | | | |
| <ANT> | <ATT> | <ATTA> | <SQUC> |
| <AFC> | <ACT> | Not used | |

Remark:

The parameter <ACT> is ignored for the RX memory-location (current RX settings). However, it must be specified.

When loading with a <packed_struct>, the byte order within the 2- and 4-byte elements is determined by the command FORMat:BORe.

Example:

```
MEMory:CONTents          1,98.5
MHz,30,FM,300,10,OFF,OFF,ON,OFF,ON
```

MEMory

. :CONTents? <mem_loc>

Query of contents of memory location.

Parameters:

<mem_loc> CURRENT|0...1023|RX

Result:

Depending on the setting by the command FORMat:MEMory, either ASCII or binary data are output. See MEM:CONT command for the format specifications.

Depending on the setting by the command FORMat:BORder, the data are either big- or little-endian.

Remark:

The parameter <ACT> is not defined for the RX location. However, it is output, so it should be ignored.

When trying to read out an empty memory location, error -292 ("Referenced name does not exist") is generated.

Example:

MEMory:CONTents? 1 -> 98500000,30,FM,300,10,0,0,1,0,1

MEMory

. :CONTents

. . :MPAR <mem_loc>,<Boolean>

Setting the memory location parameter <ACT> (MPAR = Memory PARameter).

Parameters:

<mem_loc> CURRENT|0...1023|NEXT

<Boolean> include/exclude the memory in a memory scan: 0 = OFF, 1 = ON

Example:

MEMory:CONTents:MPAR 1, OFF

MEMory

. :CONTents

. . :MPAR? <<mem_loc>>

Query of memory-location parameter <ACT>.

Parameters:

<mem_loc> CURRENT|0...1023

Result:

0, 1

Example:

MEMory:CONTents:MPAR? 1 -> 0

MEMory

. :COPY <src_loc>, <dest_loc>

Copy the contents of one memory (source) to another (destination).

Parameters:

<src_loc> CURRENT|0...1023|RX

<dest_loc> CURRENT|0...1023|NEXT|RX

Example:

MEMory:COPY 123, 10 Copy from location 123 to location 10

MEMory:COPY RX, NEXT Store current receiver settings in next free
(see MEM:CLE) location

MEMory

. :EXCHange <mem_loc1>, <mem_loc2>

Exchange of contents of two memory locations. The contents of location <mem_loc1> is swapped with that of location <mem_loc2>. In case one of the locations is RX, and RX would get an impossible value due to the exchange, the RX value remains unchanged, and the other location gets RX's value. The impossible value is thus lost.

Parameters:

<mem_loc1> CURRENT|0...1023|RX

<mem_loc2> CURRENT|0...1023|RX

Example:

MEMory:EXCHange 123, RX

MEMory

. :LABel <mem_loc>, <String>

Defines a descriptive text for a memory location

Parameters:

<mem_loc> 0...1023

Example:

MEMory:LABel 500, "Radio FM"

MEMory

. :LABel? <mem_loc>

Query of the descriptive label of a memory location

Parameter:

<mem_loc> 0...1023

Result:

String

Example:

MEMory:LABel? 500 -> "Radio FM"

11.10.1 Memory list subsystem

The commands listed in this section are only intended for testing the associated function in the user interface. They are not to be used by the remote user.

Although each memory location (0...1023) can be addressed directly, it is sometimes convenient to run through all of them in a specific order (e.g. in

order of increasing frequency). To accommodate both an unordered and an ordered access of the memory locations, the memory list is used. The memory list has a number of items, one for each memory location. Each item links to a certain memory location. This way, the order in the memory locations can remain unchanged, while the list item allow to run through the memories in another order. See below an example for ordering on increasing frequency via the memory list:

```
...
item 55    ->    25 (freq. 100000000)
item 56    ->     6 (freq. 125000000)
item 57    ->     2 (freq. 140000000)
item 58 ->   800 (freq. 160000000)
...
```

The memory scan (SENS:FREQ:MODE MSC) uses the memory list to run through all memory locations. The commands below under the MEMory:LIST subsystem control the order of the memory list.

MEMory

. :LIST

. . :CONTents? <index>

Query to which memory location a list item has been linked

Parameter:

<index> integer number in the range [0,1023]

Result:

0...1023

Example:

MEMory:LIST:CONTents? 25 -> 60

MEMory

. :LIST
 . . :MEMory? <mem_loc>

Find the memory-list item that links to <mem_loc>

Parameter:

<mem_loc> 0...1023

Result:

integer number in the range [0,1023]
 NONE No memory-list item link to <mem_loc>

Example:

MEMory:LIST:MEMory? 60 -> 25

MEMory

. :LIST
 . . :SORT <order>

Sorts the memory locations and puts the result in the memory list.

Parameters:

<order> One of the following:
 MEM_UP increasing memory-location number
 MEM_DOWN decreasing memory-location number
 FREQ_UP increasing frequency
 FREQ_DOWN decreasing frequency
 DES_UP increasing alphabetical on description
 DES_DOWN decreasing alphabetical on description

Example:

MEMory:LIST:SORT DES_DOWN

11.10.2 Memory save subsystem

This subsystem contains all commands for automatically saving receiver settings to memory locations.

MEMory

. :SAVE
 . . :AUTO
 . . . :STARt <mem_loc>

Sets first memory location that is used to save receiver settings when automatic save is active. The last location is set with MEM:SAVE:AUTO:STOP. A start location that is larger than the stop location is rejected with error -221("Settings conflict").

This setting applies to scans with squelch on (see OUTP:SQU:STOR). When the received signal is stronger than the squelch level during a memory scan or a frequency scan, the receiver settings are saved into the first free auto-save memory-location (see MEM:SAVE:AUTO:STAR and

MEM:SAVE:AUTO:STOP). This setting is ignored in case the squelch is off (see OUTP:SQU:STAT).

Parameters:

<mem_loc> 0...1023

Example:

MEMory:SAVE:AUTO:STARt 120

MEMory

. :SAVE
 . . :AUTO
 . . . :STARt?

Query of first memory location for auto save

Parameter:

none

Result:

0...1023

Example:

MEMory:SAVE:AUTO:STARt? -> 120

MEMory

. :SAVE
 . . :AUTO
 . . . :STOP <mem_loc>

Sets the last memory location that is used to save receiver settings when automatic save on squelch is active (see OUTP:SQU:STOR). The first location is set with MEM:SAVE:AUTO:STAR. A stop location that is smaller than the start location is rejected with error -221("Settings conflict").

Parameters:

<mem_loc> 0...1023

Example:

MEMory:SAVE:AUTO:STOP 180

MEMory

. :SAVE
 . . :AUTO
 . . . :STOP?

Query of the last memory location used for auto save.

Parameter:

none

Result:

0...1023

Example:

MEMory:SAVE:AUTO:STOP? -> 180

MEMory

```

. :SAVE
. . :DIRect
. . . :STARt <mem_loc>

```

Sets first memory location that is used to save receiver settings when the direct save button is pressed. The last location is set with MEM:SAVE:DIR:STOP. A start location that is larger than the stop location is rejected with error -221("Settings conflict"). When the direct save button is pressed, the receiver settings are saved into the first free direct-save memory-location.

Parameters:

<mem_loc> 0...1023

Example:

MEMory:SAVE:DIRect:STARt 60

MEMory

```

. :SAVE
. . :DIRect
. . . :STARt?

```

Query of first memory location for direct save

Parameter:

none

Result:

0...1023

Example:

MEMory:SAVE:DIRect:STARt? -> 60

MEMory

```
. :SAVE
. . :DIRect
. . . :STOP <mem_loc>
```

Sets the last memory location that is used to save receiver settings when the direct save button is pressed. The first location is set with MEM:SAVE:DIR:STAR. A stop location that is smaller than the start location is rejected with error -221("Settings conflict").

Parameters:

<mem_loc> 0...1023

Example:

MEMory:SAVE:DIRect:STOP 120

MEMory

```
. :SAVE
. . :DIRect
. . . :STOP?
```

Query of last memory location used for direct save

Parameter:

none

Result:

0...1023

Example:

MEMory:SAVE:DIRect:STOP? -> 120

11.11 MMEMory subsystem

This subsystem contains all commands that act on the mass storage of the MR, e.g. SD-Card.

MMEMory

```
. :CATalog?
```

List the files in the current directory of the mass storage device.

Parameter:

none

Result:

```
<used_storage>, <available_storage> {, <file_entry>}
<file_entry> = <file_name>, <file_type>, <file_size>, <file_date>, <file_time>
<used_storage>    used storage in bytes
<available_storage>    available storage in bytes
```

<file_name> string of characters
<file_type> the file extension (part after the last dot in the name)
<file_size> size of the file in bytes
<file_date> date of file in format <day>, <month>, <year>
The format is NOT influenced by the DISP:DATE:FORM
command.
<file_time> time of file in format <hours>, <minutes>, <seconds>

Example:

```
MMEMemory:CATalog? ->  
3000, 120000000,  
file 1, txt, 1000, 14-12-2006, 19:05:03,  
file 2, log, 2000, 15-11-2005, 21:07:08
```

MMEMory**. :CATalog****. . :DIRectories?**

List the directories in the current directory of the mass storage device.

Parameter:

none

Result:

<used_storage>, <available_storage> {, <file_entry>}

<file_entry> = <file_name>, <file_type>, <file_size>

<used_storage> used storage in bytes

<available_storage> available storage in bytes

<file_name> string of characters

<file_date> date of file in format <day>, <month>, <year>

The format is NOT influenced by the DISP:DATE:FORM

command.

<file_time> time of file in format <hours>, <minutes>, <seconds>

Example:

MMEMory:CATalog? ->

3000, 120000000,

directory 1 ,1000, 14-12-2006, 19:05:03,

directory 2 ,2000, 15-11-2005, 21:07:08

MMEemory**. :CDIRectory <folder_name>**

Change the default (current) folder (directory) to the specified one. The default folder is used for all other MMEemory commands and queries. In case the folder does not exist, an error is generated: `.-292, "Referenced name does not exist"`

Parameters:

<folder_name> String of characters (comma not allowed)

Example:

MMEemory:CDIRectory "SomeFolder"

MMEemory**. : CDIRectory?**

Returns the default (current) folder (directory).

Parameters:

None

Result:

<folder_name> String of characters

Example:

MMEemory:CDIRectory? -> "SomeFolder"

MMEemory**. :COPY <src_name>, <dest_name>**

Copies the file or folder <src_name> to <dest_name>. In case <src_name> does not exist in the current folder, an error is generated: `.-292, "Referenced name does not exist"`. In case <dest_name> already exists in the current folder, an error is generated: `.-293, "Referenced name already exists"`.

Parameters:

<src_name> source file/folder: String of characters (comma not allowed)
<dest_name> destination file/folder: String of characters (comma not allowed)

Example:

MMEemory:COPY "file1", "file3"

MMEMemory

. :DATA <file_name>, <block_data>

Creates a new file, or overwrites an existing one, with the name <file_name>, and fills it with the binary data in <block_data>

Parameters:

<file_name> file: String of characters (comma not allowed)

<block_data> block data

Example:

MMEMemory:DATA "test.txt", #15hello

MMEMemory

. : DATA? <file_name>

Outputs the contents of the file <file_name> as block data. In case <file_name> does not exist, an error is generated: .-292, "Referenced name does not exist".

Parameters:

<file_name> file: String of characters (comma not allowed)

Result:

<block_data> of file contents

Example:

MMEMemory:DATA? "test.txt" -> #15hello

MMEMemory

. :DELeTe < name>

Removes the file <name> from the current folder of the mass storage device. In case <name> does not exist, an error is generated: .-292, "Referenced name does not exist".

Parameters:

<name> String of characters (comma not allowed)

Example:

MMEMemory:DELeTe "file"

MMEMemory

. :FILE <file_name>, <block_data>

Alias of MMEM:DATA

Remark:

See MMEM:DATA

MMEMemory

. : FILE? <file_name>

Alias of MMEM:DATA?

Remark:

See MMEM:DATA?

MMEMemory

. :FILE

. . :DATE <file_name>, <year>, <month>, <day>

Sets the modification date of an existing file. In case <file_name> does not exist, an error is generated: -292, "Referenced name does not exist".

Parameters:

<file_name> file: String of characters (comma not allowed)

<block_data> block data

<year> integer number in the range [2000-2099]

<month> integer number in the range [1,12] (1 = January, 12 = December)

<day> integer number in the range [1,31]

Error:

In case the date is invalid, an execution error -200, "Execution error" is generated.

Example:

MMEMemory:FILE:DATE "test.txt", 2006, 12, 14

MMEMemory

. : FILE
. . : DATE? <file_name>

Outputs the modification date of an existing file. In case <file_name> does not exist, an error is generated: -292, "Referenced name does not exist".

Parameters:

<file_name> file: String of characters (comma not allowed)

Result:

<year>, <month>, <day> (See MMEM:FILE:DATE)

Example:

MMEMemory:FILE:DATE? "test.txt" -> 2006, 14, 12, 14

MMEMemory

. : FILE
. . : TIME <file_name>, <hours>, <minutes>, <seconds>

Sets the modification time of an existing file. In case <file_name> does not exist, an error is generated: -292, "Referenced name does not exist".

Parameters:

<file_name> file: String of characters (comma not allowed)

<block_data> block data

<hours> integer number in the range [0:23]

<minutes> integer number in the range [0:59]

<seconds> any number in the range [0:60]

The seconds are specified by a real number that is rounded toward the resolution of the device's internal clock accuracy. The number 60 is allowed here, because rounding can yield a number larger than 59.5.

Error:

In case the time is invalid, an execution error -200, "Execution error" is generated.

Example:

MMEMemory:FILE:TIME "test.txt", 22, 23, 24.09

MMEMemory

. : FILE
 . . :TIME? <file_name>

Outputs the modification time of an existing file. In case <file_name> does not exist, an error is generated: `.-292, "Referenced name does not exist"`.

Parameters:

<file_name> file: String of characters (comma not allowed)

Result:

<hours>, <minutes>, <seconds> (See MME:FILE:TIME)

Example:

MMEMemory:FILE:TIME? "test.txt" -> 22, 23, 24.09

MMEMemory

. :INIT [<label>]

Deletes all files and directories from the mass storage device. After that, it restores default directories and files that are needed for correct operation of the device, and assigns a label to the mass storage.

Parameters:

none The existing label for the mass storage is not changed
 <label> String of character for the new label for the mass storage

Example:

MMEMemory:INIT "Measurements"

MMEMemory

. :MDIRectory <folder_name>

Creates a new folder <folder_name> in the current folder of the mass storage device. In case <folder_name> already exists in the current folder, an error is generated: `.-293, "Referenced name already exists"`.

Parameters:

<folder_name> String of characters (comma not allowed)

Example:

MMEMemory:MDIRectory "SomeFolder"

MMEMemory

. :MOVE <src_name>, <dest_name>

Renames the file or folder <src_name> into <dest_name>. In case <name> does not exist in the current folder, an error is generated: `.-292, "Referenced name does not exist"`. In case <dest_name> already exists in the current folder, an error is generated: `.-293, "Referenced name already exists"`.

Parameters:

<src_name> source file/folder: String of characters (comma not allowed)
 <dest_name> destination file/folder: String of characters (comma not allowed)

Example:

MMEemory:MOVE "file1", "file2"

MMEemory

. :RDIRECTORY <folder_name>

Removes an existing folder <folder_name> in the current folder of the mass storage device. In case <name> does not exist in the current folder, an error is generated: .-292, "Referenced name does not exist".

Parameters:

<folder_name> String of characters (comma not allowed)

Example:

MMEemory:MDIRECTORY "SomeFolder"

11.12 OUTPUT subsystem**OUTPUT**

. :AUX
 . . :AUTO <Boolean>

Sets whether the auxiliary bits on AUX1 are automatically determined by the selected antenna or if they are manually affected by using the BITAux or BYTAux commands.

***Parameters:**

ON Automatic
 OFF Manual

Example:

OUTPUT:AUX:AUTO ON

**OUTPUT**

. :AUX
 . . :AUTO?

Queries whether the auxiliary bits on AUX1 are automatically determined by the selected antenna or if they are manually affected by using the BITAux or BYTAux commands.

***Parameters:**

0 Manual
1 Automatic

Example:

OUTPut:AUX:AUTO? -> 1

▸

OUTPut

. :BITaux[<numeric_suffix>]
. . [:STAtE] <Boolean>

Sets the antenna-selection bits. In case another antenna is chosen via ROUT:SEL, these settings are changed again.

<numeric_suffix>

1 bit 1 corresponds to antenna-bit 1
2 bit 2 corresponds to antenna-bit 2

***Parameters:**

ON Bit set to 1
OFF Bit set to 0

Example:

OUTPut:BITaux2 ON

▸

OUTPut

. :BITaux[<numeric_suffix>]
. . [:STAtE] ?

Query of the antenna-selection bits.

Result:

0 OFF
1 ON

Parameters:

none

Example:

OUTPut:BITaux2? -> 1

**OUTPut**

. :BYTAux
. . [:STATE] <numeric_value>

Sets all antenna-selection bits with a single command.

Parameters:

<numeric_value>

value of the antenna-selection bits (0 to 3, #H00 to #H03, #B0 to #B11, #Q0 to #Q3)

***RST state:**

0

Example:

OUTPut : BYTAux 7

**OUTPut**

. :BYTAux
. . [:STATE]?

Query of all antenna-selection bits by a single byte command.

Parameters:

none

Result:

The output format depends on the FORMat:SREG command.

Example:

OUTPut : BYTAux? -> 3

**OUTPut**

. :IF
. . [:STATE] <Boolean>

Sets the IF output state. If it is ON, the MR activates a separate output on which it puts the received-signal, that has been mixed downwards to the IF frequency and bandwidth limited to 10 MHz.

***Parameters:**

ON Bit set to 1
OFF Bit set to 0

Example:

OUTPut:IF:STATE ON

**OUTPut**

. :IF
. . [:STATE] ?

Query of IF output state

Result:

0 OFF
1 ON

Parameters:

none

Example:

OUTPut:IF:STATE? -> 1

**OUTPut**

- . :SQUelch
- . . :CONTRol MEMory|NONE

When retrieving RX settings from a memory location, the squelch state and value are also retrieved when OUTP:SQU:CONT is set to MEMory. Otherwise, the squelch state and value are not retrieved and their settings remain unchanged.

Parameters:

MEMory squelch state and squelch value are read out of the memory locations
NONE squelch state and squelch value are not read out of the memory locations

Example:

OUTPut:SQUelch:CONTRol MEMory

**OUTPut**

- . :SQUelch
- . . :CONTRol?

Query of the source of squelch setting when reading memory locations.

Parameters:

none

Result:

MEM, NONE

Example:

OUTPut:SQUelch:CONTRol? -> MEM

**OUTPut**

- . :SQUelch
- . . [:STATe] <Boolean>

Switch on/off of squelch.

Parameters:

ON squelch on
OFF squelch off

Example:

OUTPut:SQUelch ON

**OUTPut**

- . :SQUelch
- . . [:STATe]?

Query of squelch setting.

Parameters:

none

Result:

0 OFF
1 ON

State:

OUTPut:SQUelch? -> 1



OUTPut

```
. :SQUelch
. . :THReshold
. . . [:UPPer] <numeric_value>|UP|DOWN|MINimum|MAXimum
```

Setting of squelch threshold.

Parameters:

<numeric_value> squelch threshold in dB μ V
 UP|DOWN increase|decrease of squelch threshold by the value set with the command
 OUTPut:SQUelch:THReshold[:UPPer]:STEP[:INCRement].
 MINimum|MAXimum setting the lowest/highest squelch threshold

Example:

```
OUTPut:SQUelch:THReshold 35 dBuV
```



OUTPut

```
. :SQUelch
. . :THReshold
. . . [:UPPer]? [MINimum|MAXimum]
```

Query of squelch threshold.

Parameters:

none query of current squelch threshold
 MINimum|MAXimum query of lowest/highest squelch threshold

Result:

squelch threshold value in dB μ V

Example:

```
OUTPut:SQUelch:THReshold? -> 35
```



OUTPut

```
. :SQUelch
. . :THReshold
. . . [:UPPer]
. . . . :STEP
. . . . . [:INCRement] <numeric_value>|MINimum|MAXimum
```

Setting the stepwidth for the command OUTP:SQU:THR[:UPP] UP|DOWN

Parameters:

<numeric_value> stepwidth of squelch threshold in dB μ V
 MINimum|MAXimum setting the smallest|largest stepwidth

Example:

```
OUTP:SQU:THR:STEP 10 dBuV
```



OUTPut

```
. :SQUelch
. . :THReshold
. . . [:UPPer]
. . . . :STEP
. . . . . [:INCRement]? [MINimum|MAXimum]
```

Query of squelch stepwidth

Parameters:

none query of currently set stepwidth
 MINimum|MAXimum query of smallest|largest stepwidth

Result:

Stepwidth of squelch threshold in dB μ V

Example:

```
OUTP:SQU:THR:STEP? -> 10
```

**OUTPut**

. :TONE

. . :CONTRol ONLY|WITHaf

It can be selected whether, in the TONE mode, only the level tone or also the AF is output via the audio channel.

Parameters:

WITHaf level tone and AF is output.

ONLY only level tone is output.

Example:

OUTPut:TONE:CONTRol ONLY

**OUTPut**

. :TONE

. . :CONTRol?

Query of whether, in the TONE mode, only the level tone or also the AF is output via the audio channel.

Parameters:

none

Result:

ONLY, WITH

Example:

OUTPut:TONE:CONTRol? -> ONLY



OUTPut

. :TONE

. . :GAIN <numeric_value>|MINimum|MAXimum|UP|DOWN

Setting of tone gain. See also OUTP:TONE:THR for a description of its use.

Parameters:

<numeric_value> Tone gain in Octave/ <numeric_value>dB

MINimum|MAXimum setting the lowest/highest tone gain

Remark:

The range can be set in discrete steps. Intermediate values are therefore rounded to the nearest discrete value.

Example:

OUTPut:TONE:GAIN 20



OUTPut

. :TONE

. . :GAIN? [MINimum|MAXimum]

Query of tone gain

Parameters:

none query of current tone gain

MINimum|MAXimum query of lowest/highest tone gain

Result:

Tone gain in Octave/ <numeric_value>dB

Example:

OUTPut:TONE:GAIN? -> 20

**OUTPut**

. :TONE

. . [:STATE] <Boolean>

Switch on/off of level tone function. When on, a tone is output depending on the level magnitude.

Parameters:

ON level tone on

OFF level tone off

Example:

OUTPut:TONE ON

**OUTPut**

. :TONE

. . [:STATE] ?

Query of the TONE mode.

Parameters:

none

Result:

0 OFF

1 ON

Example:

OUTPut:TONE? -> 1



OUTPut

. :TONE

. . :THReshold <numeric_value>|UP|DOWN|MINimum|MAXimum

Setting the tone-level reference-threshold. It determines what signal level is to be output as 400 Hz: e.g. usually this is set to 0 dB μ V, which means that a signal of that strength produces a tone of 400 Hz. Together with the settings OUTP:TONE:GAIN, this setting determines the frequency of the tone for each received signal level.

Parameters:

<numeric_value> level tone reference threshold in dB μ V

UP|DOWN increase|decrease of level tone reference threshold by the value set in the

OUTPut:TONE:THReshold:STEP[:INCRement]
command.

MINimum|MAXimum setting the lowest/highest level tone reference threshold

Example:

OUTPut:TONE:THReshold 35 dBuV



OUTPut

. :TONE

. . :THReshold? [MINimum|MAXimum]

Query of level tone reference threshold.

Parameters:

none query of current level tone reference threshold

MINimum|MAXimum query of lowest/highest level tone reference threshold

Result:

Level tone reference threshold in dB μ V

Example:

OUTPut:TONE:THReshold? MIN -> 6



OUTPut

```
. :TONE
. . :THReshold
. . . :STEP
. . . . [:INCRement] <numeric_value>|MINimum|MAXimum
```

Setting the stepwidth for the OUTP:TONE:THR UP|DOWN command.

Parameters:

<numeric_value> stepwidth for level tone reference threshold in dB μ V
 MINimum|MAXimum setting the smallest/largest stepwidth

Example:

```
OUTP:TONE:THR:STEP 10 dB $\mu$ V
```



OUTPut

```
. :TONE
. . :THReshold
. . . :STEP
. . . . [:INCRement]? [MINimum|MAXimum]
```

Query of tone-threshold stepwidth.

Parameters:

none query of currently set stepwidth
 MINimum|MAXimum query of smallest/largest stepwidth

Result:

Stepwidth for level tone reference threshold in dB μ V

Example:

```
OUTP:TONE:THR:STEP? -> 10
```

11.13 Program preset subsystem

This sub-system allows saving of all settings of the device as a “preset”. The settings saved into a preset can be recalled, after which all the settings in the preset are restored. The commands below allow for saving to and recalling from presets.

▶

PROG:PRESet

. : PRESet

. . :CATalog?

Query of available presets

Parameters:

none

Remark:

Beware that user defined preset names, using PROG:PRES:DEF <name>, are not visible in the User Interface of the instrument. The User Interface always display User Preset <nr> regardless the entered name via SCPI. The name display User Preset <nr> is used when the user stores a preset via the User Interface.

Result:

comma separated list of preset-names.

Example:

PROG:PRES:CAT? -> “User Preset 1”, “User Preset 2”

**PROG**

. : PRESet

. . :DEFine <name>

Defines the name <name> for all current settings of the device.

Parameters:

<name> String of characters enclosed in double quotes

Remark:

Beware that user defined preset names, using PROG:PRES:DEF <name>, are not visible in the User Interface of the instrument. The User Interface always display User Preset <nr> regardless the entered name via SCPI. The name display User Preset <nr> is used when the user stores a preset via the User Interface.

The name parameters has a limit of 20 characters.

Each name in the list should be unique.

Error:**Example:**

PROG:PRES:DEFine "User Preset 1"

**PROG**ram

. : PRESet

. . :DELeTe <name>

Deletes a preset with the name <name>.

Parameters:

<name> String of characters enclosed in double quotes

Error:

-292 Referenced name, preset, does not exist.

Example:

PROG:PRES:DELeTe "User Preset 1"

**PROG**ram

. : PRESet

. . :DELeTe

. . . :ALL

Deletes all saved presets

Parameters:

none

Example:

PROG:PRES:DELeTe:ALL



PROGram

- . : **PRE**Set
- . . : **SE**Lect <name>

Recalls all settings of a preset with the name <name>, and restores those settings in the device. When a preset with the specified name is not present, the error -292, "Referenced name does not exist" is generated.

Parameters:

<name> String of characters enclosed in double quotes

Example:

PROG:PRE:SElect "User Preset 1"

11.14 SENSE Subsystem

[SENSE]

- . : **BAND**width|**BWID**th
- . . [:**RE**Solution] <numeric_value>|**UP**|**DOWN**|**MIN**imum|**MAX**imum

Selection of bandwidth of demodulation path. Only certain bandwidths are allowed. If a number is specified, the smallest bandwidth that is still larger is selected.

Parameters:

<numeric_value> bandwidth in Hz
 UP|DOWN to next|previous bandwidth
 MINimum|MAXimum setting the narrowest|widest bandwidth

Example:

BANDwidth 2.4 kHz

[SENSE]

- . : **BAND**width|**BWID**th
- . . [:**RE**Solution]? [**MIN**imum|**MAX**imum]

Query of current IF bandwidth.

Parameters:

none query of current bandwidth
 MINimum|MAXimum query of narrowest|widest bandwidth

Result:

bandwidth in Hz

Example:

BANDwidth? -> 2400

[SENSe]

- . :CORRection
- . . :ANTenna ACTive|PASSive

Sets the mode of the selected antenna.

Parameters:

ACTive For active (= amplifying) antennas
PASSive For passive (= non amplifying) antennas

Example:

SENSe:CORRection:ANTenna ACT

[SENSe]

- . :CORRection
- . . :ANTenna?

Query of antenna mode

Parameters:

none

Result:

ACT, PASS

Example:

SENSe:CORRection:ANTenna? -> ACT

[SENSe]**. :DATA? [<data_handle>]**

Query of the most current measured values of active sensor functions. Measurement values may not be available yet at the moment when this query is issued, for example. immediately after a receiver setting have been changed. If this is the case the query will block until the data will become available. If MEASurement:MODE is CONTinuous this may take up to 200 ms, if PERiodic it may take up to the measurement time (MEASurement:TIME).

The unit may actively report the end of measurement (MEASuring bit in operation status register becomes inactive) via SRQ if the status register has been configured accordingly (see also Section 9).

Remark:

For this command the keyword SENSE must not be omitted as DATA? can be mixed up with the subsystem TRACe:DATA.

When the scan mode is PSCan, this command returns the error -221 ("Settings conflict").

Parameters:

none Output of the measured values of all active sensor functions.
 <data_handle> see the command SENS:FUNC:ON for the available functions

Error:

If a requested function is not switched on, or if no functions are switched on, error -221, "Settings Conflict" is generated.

Result:

The values for the various data-handles are output in the order as specified under the SENS:FUNC:ON command. The output format (ASCii or block data) is determined by the command FORMat:DATA. If the output format is block data, the command FORMat:BORDER defines whether the data is output in big- or little-endian byte order.

| data_handle | C Data-Type | Description |
|--------------------|--------------|--|
| "VOLTage:AC" | signed short | level in 0.1 dB μ V (block data) level in 1.0 dB μ V (ASCii data) |
| "FREQuency:OFFSet" | signed long | offset in Hz |
| "FSTRength" | signed short | field strength in 0.1 dB μ V/m (block data) field strength in 1.0 dB μ V/m (ASCii data) |

Examples:

SENSe:DATA? -> 23.4, -2500
 SENSe:DATA? "VOLT:AC" -> 23.4
 SENSe:DATA? "FREQuency:OFFSet" -> -2500
 SENSe:DATA? "FSTRength" -> 45.4

[SENSe]

. :DEModulation AM|FM| PULSe|CW|LSB|USB|IQ|ISB|A0|A1

Switchover of type of demodulation.

Parameters:

FM switch on FM demodulator

AM switch on AM demodulator

PULSe switch on pulse demodulator

CW, A1 switch on SSB demodulator with a beat frequency

USB switch on SSB demodulator upper sideband

LSB switch on SSB demodulator lower sideband

IQ, A0 switch on IQ demodulator

ISB switch on ISB demodulator

Remark:

For SSB demodulation (CW, LSB and USB,) the frequency stepwidth is set to 1 Hz.

Error:

If the bandwidth exceeds 9 kHz at CW, LSB and USB, an error -221, "Settings conflict" is generated if one of the SSB operating modes is to be switched on.

Example:

DEModulation AM

[SENSe]

. :DEModulation?

Query of demodulation type.

Parameters:

none

Result:

FM, AM, PULS, CW, USB, LSB, IQ, ISB

Example:

DEModulation? -> AM

[SENSe]

. :DEModulation
. . :BFO
. . . :FREQuency <numeric_value>|MINimum|MAXimum

Set the beat frequency.

Parameters:

<numeric_value> value of beat frequency
MINimum|MAXimum setting the lowest|highest beat frequency

Example:

SENSe:DEModulation:BFO:FREQuency 2.4 kHz

[SENSe]

. :DEModulation
. . :BFO
. . . :FREQuency? [MINimum|MAXimum]

Query of beat frequency.

Parameters:

none query of current beat frequency
MINimum|MAXimum query of lowest|highest beat frequency

Result:

beat frequency in Hz

Example:

SENSe:DEModulation:BFO:FREQuency? -> 2400

[SENSe]

- . :DETECTOR
- . . [:FUNCTION] AVG|FAST|PEAK|RMS

Selecting the level-measuring process.

Parameters:

AVG measure the average value
FAST measure the instantaneous value
PEAK measure the maximum peak-value
RMS measure the root-mean-square value

Example:

DETECTOR RMS

[SENSe]

- . :DETECTOR
- . . [FUNCTION]?

Query of the level-measuring process.

Parameters:

none

Result:

AVG, FAST, PEAK, RMS

Example:

DETECTOR? RMS

[SENSe]

. :FREQuency
. . :AFC <Boolean>

Switch on/off the AFC function. If AFC is not possible for the currently selected receiver mode, error -221, "Settings conflict" is generated.

Parameters:

ON AFC function on
OFF AFC function off

Example:

SENSe:FREQuency:AFC ON

[SENSe]

. :FREQuency
. . :AFC?

Query of AFC function.

Parameters:

none

Result:

0 OFF
1 ON

Example:

SENSe:FREQuency:AFC? -> 1

[SENSe]

. :FREQuency
 . . :CONVersion
 . . . :THReshold <numeric_value>|MINimum|MAXimum

Set the conversion threshold. This determines at which frequency the device switches from normal to direct path reception. During normal reception, the signal is modulated downward to an intermediate frequency. When the frequency drops below the conversion threshold, the downward modulation is skipped, hence the name “direct path” reception.

Parameters:

<numeric_value> value of conversion threshold
 MINimum|MAXimum setting the lowest|highest conversion threshold

Example:

SENSe:FREQuency:CONVersion:THReshold 27 MHz

[SENSe]

. :FREQuency
 . . :CONVersion
 . . . :THReshold? [MINimum|MAXimum]

Query of conversion threshold.

Parameters:

none query of current conversion threshold
 MINimum|MAXimum query of lowest|highest conversion threshold

Result:

conversion threshold in Hz

Example:

SENSe:FREQuency:CONVersion:THReshold? -> 27000000

[SENSe]

. :FREQuency

. . [:CW|FIXed] <numeric_value>|UP|DOWN|MINimum|MAXimum

Setting of receiver frequency.

Parameters:

<numeric_value> frequency value

UP|DOWN increase|decrease of receiver frequency by the value set in the command

SENS:FREQuency[:CW|FIX]:STEP[:INCRement]
MINimum|MAXimum setting the lowest|highest receiver frequency

Example:

FREQuency 101.2 MHz

[SENSe]

. :FREQuency

. . [CW|FIXed]? [MINimum|MAXimum]

Query of receiver frequency.

Parameters:

none query of current receiver frequency

MINimum|MAXimum query of lowest|highest receiver frequency

Result:

Frequency value in Hz

Example:

FREQuency? -> 101200000

[SENSe]

```

. :FREQuency
. . [:CW|FIXed]
. . . :STEP
. . . . [:INCRement] <numeric_value>| MINimum|MAXimum

```

Setting of receiver frequency.step size

Parameters:

<numeric_value> frequency value
 MINimum|MAXimum setting the lowest|highest frequency step size

Example:

FREQuency:STEP 1 MHz

[SENSe]

```

. :FREQuency
. . [CW|FIXed]
. . . :STEP
. . . . [:INCRement]? [MINimum|MAXimum]

```

Query of receiver frequency.

Parameters:

none query of current frequency step size
 MINimum|MAXimum query of lowest|highest frequency step size

Result:

Frequency value in Hz

Example:

FREQuency:STEP? -> 1000000

[SENSe]

. :FREQUENCY
. . :MODE CW|FIXed|SWEep|MSCan|PSCan

Changing the operating mode of the receiver.

Parameters:

CW | FIXed receiver monitors a frequency (CW and FIXed have equal meanings)

SWEep receiver is in frequency-scan mode (see SENSe:SWEep)

MSCan receiver is in memory-scan mode (see SENSe:MSCan)

PSCan receiver is in panorama-scan mode (see SENSe:PSCan)

Remark:

The receiver stays on the CW frequency until it starts scanning.

Example:

FREQUENCY : MODE SWEep

[SENSe]

. :FREQUENCY
. . :MODE?

Query of receiver operating mode.

Parameters:

none

Result:

CW, SWE, MSC, PSC

Example:

FREQUENCY:MODE? -> SWE

[SENSe]

. :FREQUency
 . . :PSCan
 . . . :CENTer <numeric_value>|MINimum|MAXimum

Setting of center frequency of an RF-panorama scan. This command uses "SENS:FREQ:PSC:SPAN?" to calculate new start and stop frequencies. It thus changes SENS:FREQ:PSC:STAR and SENS:FREQ:PSC:STOP.

Parameters:

<numeric_value> center frequency
 MINimum|MAXimum setting the lowest|highest center frequency

Example:

FREQUency:PSC:CENTer 127 MHz

[SENSe]

. :FREQUency
 . . :PSCan
 . . . :CENTer? [MINimum|MAXimum]

Query of center frequency of an RF-panorama scan.

Parameters:

none query of current center frequency
 MINimum|MAXimum query of lowest|highest center frequency

Result:

Frequency in Hz

Example:

FREQUency:PSC:CENTer? -> 127000000

[SENSe]

. :FREQuency
 . . :PSCan
 . . . :SPAN <numeric_value>|MINimum|MAXimum

Setting the frequency span of an RF-panorama scan. This command uses "SENS:FREQ:PSC:CENT?" to calculate new start and stop frequencies. It thus changes SENS:FREQ:PSC:STAR and SENS:FREQ:PSC:STOP.

Parameters:

<numeric_value> frequency span
 MINimum|MAXimum setting the lowest|highest frequency span

Example:

FREQuency:SPAN 2 MHz

[SENSe]

. :FREQuency
 . . :PSCan
 . . . :SPAN? [MINimum|MAXimum]

Query of the frequency span of an RF-panorama scan.

Parameters:

none query of current frequency span
 MINimum|MAXimum query of lowest|highest frequency span

Result:

Frequency in Hz

Example:

FREQuency:SPAN? -> 2000000

[SENSe]

. :FREQuency
 . . :PSCan
 . . . :STARt <numeric_value>|MINimum|MAXimum

Setting of start frequency of an RF-panorama scan. This value is mapped onto the same variable as the frequency scan start frequency, meaning that if the start frequency changes for PSCan it automatically changes for frequency scan, SWE, as well. This setting modifies SENS:FREQ:PSC:SPAN and SENS:FREQ:PSC:CENT.

The start frequency must be smaller than the stop frequency. A start frequency that is larger than the stop frequency is rejected with error -221("Settings conflict").

Parameters:

<numeric_value> frequency
 MINimum|MAXimum setting the lowest|highest start frequency

Example:

FREQuency:STARt 118 MHz

[SENSe]

. :FREQuency
 . . :PSCan
 . . . :STARt? [MINimum|MAXimum]

Query of start frequency of an RF-panorama scan. This command is alias for SENS:FREQ:STAR?.

Parameters:

none query of current start frequency
 MINimum|MAXimum query of lowest|highest start frequency

Result:

Frequency in Hz

Example:

FREQuency:STARt? -> 118000000

[SENSe]

. :FREQuency
 . . :PSCan
 . . . :STOP <numeric_value>|MINimum|MAXimum

Setting the stop frequency of an RF-panorama scan. This value is mapped onto the same variable as the frequency scan stop frequency, meaning that if the stop frequency changes for PSCan it automatically changes for frequency scan, SWE, as well. This setting modifies SENS:FREQ:PSC:SPAN and SENS:FREQ:PSC:CENT.

The start frequency must be smaller than the stop frequency. A start frequency that is larger than the stop frequency is rejected with error -221("Settings conflict").

Parameters:

<numeric_value> frequency
 MINimum|MAXimum setting the lowest|highest stop frequency

Example:

FREQuency:STOP 136 MHz

[SENSe]

. :FREQuency
 . . :PSCan
 . . . :STOP? [MINimum|MAXimum]

Query of a stop frequency of an RF-panorama scan. This command is alias for SENS:FREQ:STOP?

Parameters:

none query of current stop frequency
 MINimum|MAXimum query of lowest|highest stop frequency

Result:

Frequency in Hz

Example:

FREQuency:STOP? -> 136000000

[SENSe]

. :FREQUency

. . :SPAN <numeric_value>|UP|DOWN |MINimum|MAXimum

Selection of frequency span for IF panorama. Only certain discrete ranges are offered. If an unavailable frequency range is entered it will be brought up to the next higher discrete range.

Parameters:

<numeric_value> frequency range

UP|DOWN taking the range after|before the current bandwidth

MINimum|MAXimum setting the minimum|maximum frequency range

Example:

FREQUency:SPAN 25 kHz

[SENSe]

. :FREQUency

. . :SPAN? [MINimum|MAXimum]

Query of frequency span for IF panorama.

Parameters:

none query of current frequency range

MINimum|MAXimum query of minimum|maximum frequency range

Result:

Frequency value Hz

Example:

FREQUency:SPAN? 25000

[SENSe]

. :FREQuency

. . :STARt <numeric_value>|MINimum|MAXimum

Setting of start frequency of a frequency scan. This value is mapped onto the same variable as the PSCan start frequency, meaning that if the start frequency changes for frequency scan, SWE, it automatically changes for PSCan as well. The start frequency must be smaller than the stop frequency. A start frequency that is larger than the stop frequency is rejected with error - 221("Settings conflict").

Parameters:

<numeric_value> frequency

MINimum|MAXimum setting the lowest|highest start frequency

Example:

FREQuency:STARt 118 MHz

[SENSe]

. :FREQuency

. . :STARt? [MINimum|MAXimum]

Query of start frequency of a frequency scan.

Parameters:

none query of current start frequency

MINimum|MAXimum query of lowest|highest start frequency

Result:

Frequency in Hz

Example:

FREQuency:STARt? -> 118000000

[SENSe]

. :FREQuency

. . :STOP <numeric_value>|MINimum|MAXimum

Setting the stop frequency of a frequency scan. This value is mapped onto the same variable as the PSCan stop frequency, meaning that if the stop frequency changes for frequency scan, SWE, it automatically changes for PSCan as well. The start frequency must be smaller than the stop frequency. A start frequency that is larger than the stop frequency is rejected with error - 221("Settings conflict").

Parameters:

<numeric_value> frequency

MINimum|MAXimum setting the lowest|highest stop frequency

Example:

FREQuency:STOP 136 MHz

[SENSe]

. :FREQuency

. . :STOP? [MINimum|MAXimum]

Query of a stop frequency of a frequency scan.

Parameters:

none query of current stop frequency

MINimum|MAXimum query of lowest|highest stop frequency

Result:

Frequency in Hz

Example:

FREQuency:STOP? -> 136000000

[SENSe]**. :FUNction****. . :CONCurrent <Boolean>**

Determines whether several sensor functions can at the same time be switched or not. If CONCurrent = OFF, the command SENSe:FUNction[:ON] has the effect of a 1-out-of-n selection (one is switched on, the previously activated is automatically switched off). If CONCurrent = ON, the command SENSe:FUNction[:ON] switches the corresponding function on, while all the other functions remain unchanged. If CONCurrent is switched from ON to OFF, the function "VOLTage:AC" is switched on and all other functions are switched off.

Parameters:

ON CONCurrent on

OFF CONCurrent off

***RST state:**

ON

Example:

FUNction:CONCurrent ON

[SENSe]**. :FUNction****. . :CONCurrent?**

Query of several sensor functions that, at the same time, can be switched or not.

Parameters:

none

Result:

0 OFF

1 ON

Example:

FUNction:CONCurrent? -> 1

[SENSe]**. :FUNcTion****. . :OFF <sensor_function> {,<sensor_function>}**

Switch off of one or several sensor functions. See SENS:FUNC:ON for a list of functions.

Parameters:**Remark:**

If any of the sensor functions is changed, the trace data set MTRACE is always deleted.

see SENSe:FUNcTion[:ON]

***RST state:**

"FREQ:OFFS", "FSTR"

Example:

FUNcTion:OFF "FREQ:OFFS"

[SENSe]**. :FUNcTion****. . :OFF?**

Query of the sensor functions being switched off.

Parameters:

none

Result:

List of the sensor functions being switched off. For a list see SENSe:FUNcTion[:ON] .

Example:

FUNcTion:OFF? -> "FREQ:OFFS"

```
[SENSe]
. :FUNction
. . :OFF
. . . :COUNT?
```

Query of the number of sensor functions being inactive.

Parameters:

none

Result:

Number of sensor functions being inactive

Example:

FUNCTION:OFF:COUNT? -> 2

```
[SENSe]
. :FUNction
. . [:ON] <sensor_function> {,<sensor_function>}
```

Switch on of one or several sensor functions.

Parameters:

<sensor_function> is one of the following strings:

| | |
|--------------------|--------------------------------------|
| "VOLTage:AC" | switch on level measurement |
| "FREQuency:OFFSet" | switch on offset measurement |
| "FSTRength" | switch on field strength measurement |

Remark:

If any of the sensor functions is changed, the trace data set MTRACE is always deleted.

Error message:

If CONCurrent = OFF, an error -108, "Parameter not allowed" will be generated for two or several parameters.

***RST state:**

"VOLTage:AC"

Example:

FUNCTION "VOLT:AC", "FREQ:OFFS"

```
[SENSe]
. :FUNction
. . [:ON]?
```

Query of sensor functions being switched on.

Parameters:

none

Result:

List of sensor functions switched on. If no function is active, a zero string ("") is output. The list has a specific order:

1. "VOLT:AC" level measurement switched on
2. "FREQ:OFFS" offset measurement switched on
3. "FSTR" field strength measurement switched on

Example:

FUNCTION? -> "VOLT:AC", "FREQ:OFFS"

[SENSe]

. :FUNCTION

. . [:ON]

. . . :COUNT?

Query of the number of sensor functions being active.

Parameters:

none

Result:

Number of sensor functions being active

Example:

FUNCTION:Count? -> 2

[SENSe]

. :GCONtrol

. . [:FIXed|MGC] <numeric_value>|UP|DOWN|MINimum|MAXimum

Setting of MGC value.

Parameters:

<numeric_value> gain control factor in dB

UP|DOWN increase|decrease of the MGC value by the value set in the command

SENSe:GCONtrol[:FIXed|MGC]:STEP[:INCRement].
MINimum|MAXimum setting the smallest|largest MGC value

MIN = no gain control -> maximum sensitivity

MAX = maximum gain control -> minimum sensitivity

Example:

GCONtrol 50

[SENSe]

. :GCONtrol
 . . [:FIXed|MGC]? [MINimum|MAXimum]

Query of the MGC value.

Parameters:

none query of current MGC value
 MINimum|MAXimum query of smallest|largest MGC value

Result:

Gain control

Example:

GCONtrol? -> 50

[SENSe]

. :GCONtrol
 . . [:FIXed|MGC]
 . . . :STEP
 [:INCRement] <numeric_value>|MINimum|MAXimum

Setting the stepwidth for the command SENSe:GCONtrol[:FIXed|MGC]
 UP|DOWN.

Parameters:

<numeric_value> MGC stepwidth
 MINimum|MAXimum smallest|largest stepwidth

Example:

GCONtrol:STEP 10

[SENSe]

```

. :GCONtrol
. . [:FIXed|MGC]
. . . :STEP
. . . . [:INCRement]? [MINimum|MAXimum]

```

Query of the MGC stepwidth.

Parameters:

none query of currently set stepwidth
 MINimum|MAXimum query of smallest|largest stepwidth

Result:

MGC stepwidth in dB

Example:

GCONtrol:STEP? -> 10

[SENSe]

```

. :GCONtrol
. . :MODE FIXed|MGC|AUTO|AGC

```

Type of gain control

Parameters:

FIXed|MGC control is determined by MGC value
 AUTO|AGC control is automatically generated (AGC)

Example:

GCONtrol:MODE AUTO

```
[SENSe]
. :GCONtrol
. . :MODE?
```

Query of type of gain control.

Parameters:

none

Result:

FIX, AUTO

Example:

GCONtrol:MODE? -> AUTO

11.14.1 Sense Memory Scan subsystem MSC

The MSCan system controls the memory-scan function of the device, provided the memory scan has been activated by SENSE:FREQUENCY:MODE MSCan. Each scan is started by INITiate[:IMMEDIATE]. The memory locations are placed in the MEMORY subsystem and are set for query during the scan.

```
[SENSe]
. :MSCan
. . :CHANnel <mem_loc>|UP|DOWN|NEXT
```

Setting of current memory location. During the memory scan, this command is not permitted and generates error -200, "Execution error"

Parameters:

<mem_loc> memory location in the range [0...1023]

UP|DOWN the next or previous memory location

NEXT the next free memory location is selected, starting from and including the current location.

If the end of the memory list is reached without finding a free location, the search continues

at the beginning of the list. If no free location is available an error

-223 "Too much data" is generated

Example:

MSCan:CHANnel 357

```
[SENSe]
. :MSCan
. . :CHANnel?
```

Output of current memory location.

Parameters:

none

Result:

Index of current memory location.

Example:

MSCan:CHANnel? 357

[SENSe]

```

. :MSCan
. . :CONTRol
. . . :OFF <control_function> {,<control_function>}

```

Switches off one or more scan-control mechanisms. This value is mapped onto the same variable as the frequency scan control mechanism variable, meaning that a change affects both scan modes.

Parameters:

see SENSe:MSCan:CONTRol [:ON]

***RST state**

after *RST, all control mechanisms are ON

Example:

MSCan:CONTRol:OFF "STOP:SIGN"

[SENSe]

```

. :MSCan
. . :CONTRol
. . . :OFF?

```

Query of scan-control mechanisms that are switched OFF.

Parameters:

none

Result:

A list of the scan-control mechanisms that are switched off is output. For strings see SENSe:MSCan:CONTRol[:ON].

Example:

MSCan:CONTRol:OFF? -> "STOP:SIGN"

[SENSe]

. :MSCan

. . :CONTrol

. . . :[ON] <control_function> {,<control_function>}

Command for switch-on of the 'STOP:SIGNal' function. When this function is off, the memory scan stops at each location with a signal for the dwell-time. When this function is on, the dwell-time is controlled by the presence of a signal stronger than the threshold level:

During a memory-scan, the receiver moves from one memory location to another, loading the settings into the receiver. If a memory location has a signal that is stronger than the threshold level, the receiver stays on that memory location for a certain time, called dwell time. When the signal disappears during that dwell time, the receiver stays on the same location for a while, called hold time, to see if the signal re-appears. When either the hold-time or the dwell-time has elapsed, scanning continues.

If the signal does re-appear, the receiver continues the dwell time again (the dwell-time never stopped), otherwise it moves to the next memory location. This value is mapped onto the same variable as the frequency scan control mechanism variable, meaning that a change affects both scan modes.

Parameters:

<control_function> is the following string:

“STOP:SIGNal” switches the signal-controlled dwell time on

***RST state:**

after *RST, all control mechanisms are on

Example:

MSCan:CONTrol “STOP:SIGN”

[SENSe]**. :MSCan****. . :CONTRol****. . . [:ON]?**

Query of scan-control mechanism that is switched on.

Parameters:

none

Result:

A list of the scan-control mechanisms that are switched on is output. If nothing is switched on, a zero string ("") is output. The following strings can be expected:

" " no mechanism switched on

"STOP:SIGN" signal-controlled dwell-time is switched on

Example:

MSCan:CONTRol? -> "STOP:SIGN"

[SENSe]

. :MSCan

. . :COUNT <numeric_value>|MINimum|MAXimum|INFINITY

The number of MSCans to be done in response to the command "INIT:IMM". Note that the scan mode must be MSCan. This value is mapped onto the same variable as the frequency scan and pscan count variable, meaning that a change affects all scan modes.

Parameters:

<numeric_value> number of scans

MINimum|MAXimum minimum|maximum number

INFINITY infinite number

Example:

MSCan:COUNT 100

[SENSe]

. :MSCan

. . :COUNT? [MINimum|MAXimum]

Query of number of MSCans. This command is an alias of SENS:SWE:COUN?.

Parameters:

none query of current number of scans

MINimum|MAXimum query of minimum|maximum number of scans

Result:

Number of scans; 9.9E37 is output for an infinite number

Example:

MSCan:COUNT? -> 100

[SENSe]

- . :MSCan
- . . :DIRrection UP|DOWN

Sets scan direction. This value is mapped onto the same variable as the frequency scan direction variable, meaning that a change affects both scan modes.

Parameters:

- UP scans in direction of ascending memory numbers
- DOWN scans in direction of descending memory numbers

Example:

MSCan:DIRrection DOWN

[SENSe]

- . :MSCan
- . . :DIRrection?

Query of scan direction. This command is an alias of SENS:SWE:DIR?.

Parameters:

none

Result:

UP, DOWN

Example:

MSCan:DIRrection? DOWN

[SENSe]

. :MSCan

. . :DWELI <numeric_value>|MINimum|MAXimum|INFinity

Setting the dwell time. This value is mapped onto the same variable as the frequency scan dwell variable, meaning that a change affects both scan modes.

Parameters:

| | |
|-----------------|---------------------------|
| <numeric_value> | dwell time in seconds |
| MINimum MAXimum | lowest highest dwell time |
| INFinity | infinite dwell time |

Remark:

This command is used to set the dwell time per scan step, ie the time required by a step, if the squelch is switched off.

Example:

SWEep:DWEL 100 ms

[SENSe]

. :MSCan

. . :DWELI? [MINimum|MAXimum]

Query of dwell time. This command is an alias of SENS:SWE:DWEL?.

Parameters:

| | |
|-----------------|------------------------------------|
| none | query of current dwell time |
| MINimum MAXimum | query of lowest highest dwell time |

Result:

Dwell time in seconds; 9.9E37 is output for an infinite number

Example:

MSCan:DWEL? 0.10

[SENSe]

```

. :MSCan
. . :HOLD
. . . :TIME <numeric_value>|MINimum|MAXimum

```

Setting the hold time for a signal-controlled scan continuation. If the signal disappears during the dwell time, the hold time is started. After completion of the hold time, the scan is continued with the next frequency even if the dwell time has not yet been completed. If the signal exceeds the squelch threshold during the hold time, the hold time is reset and the end of the dwell time or the renewed disappearance of the signal is awaited. The hold time is only used if the control function "STOP:SIGNal" (see SENSE:MSCan:CONTROL) is switched on.

Setting the time to 0 (zero) has the same effect as switching off the control function with SENS:MSC:CONT:OFF "STOP:SIGN".

This value is mapped onto the same variable as the frequency scan hold time variable, meaning that a change affects both scan modes.

Parameters:

```

<numeric_value>  hold time in seconds
MINimum|MAXimum  lowest|highest hold time

```

Example:

```

SWEep:HOLD:TIME 100 ms

```

[SENSe]

```

. :MSCan
. . :HOLD
. . . :TIME? [MINimum|MAXimum]

```

Query of hold time. This command is an alias of SENS:SWE:HOLD:TIME?.

Parameters:

```

none              query of current hold time
MINimum|MAXimum  query of lowest|highest hold time

```

Result:

Hold time in seconds

Example:

```

MSCan:HOLD:TIME? 0.10

```

[SENSe]

. :MSCan
 . . :LIST
 . . . :STARt <numeric_value>|MINimum|MAXimum

Sets the memory list item from which a memory scan starts. A start location that is larger than the stop location is rejected with error -221("Settings conflict").

Parameters:

<numeric_value> integer number in the range [0,1023]
 MINimum|MAXimum set lowest|highest start location

Example:

SENSe:MSCan:LIST:STARt 60

[SENSe]

. :MSCan
 . . :LIST
 . . . :STARt? [MINimum|MAXimum]

Query of first memory list item for a scan.

Parameter:

<numeric_value> query of current start location
 MINimum|MAXimum query of lowest|highest possible start location

Result:

integer number in the range [0,1023]

Example:

SENSe:MSCan:LIST:STARt? -> 60

[SENSe]
 . :MSCan
 . . :LIST
 . . . :STOP <numeric_value>|MINimum|MAXimum

Sets the last memory-list item that is used for a memory scan. The first list item is set with SENS:MSC:LIST:STAR. A start location that is larger than the stop location is rejected with error -221("Settings conflict").

Parameters:

<numeric_value> integer number in the range [0,1023]
 MINimum|MAXimum set lowest|highest possible stop location

Example:

SENSe:MSCan:LIST:STOP 120

[SENSe]
 . :MSCan
 . . :LIST
 . . . :STOP? [MINimum|MAXimum]

Query of number of memory list items used for direct save

Parameter:

<numeric_value> query of current stop location
 MINimum|MAXimum query of lowest|highest possible stop location

Result:

integer number in the range [0,1023]

Example:

SENSe:MSCan:LIST:STOP? -> 120

11.14.2 Sense Panorama Scan subsystem PSC

The PSCan system controls the panorama-scan function of the device, provided the panorama scan has been activated by SENS:FREQUENCY:MODE PSCan. Each scan is started by INITiate[:IMMEDIATE].



[SENSe]
 . :PSCan
 . . :COUNT <numeric_value>|MINimum|MAXimum|INFINITY

Sets the number of RF-panorama scans. This command is an alias of SENS:SWE:COUN and also changes its setting. This value is mapped onto the same variable as the frequency scan and pscan count variable, meaning that a change affects all scan modes.

Parameters:

<numeric_value> number of scans
MIN|MAX minimum/maximum number
INFinity infinite number

Example:

PSCan:COUN 100

▶

[SENSe]

. :PSCan
. . :COUNT? [MINimum|MAXimum]

Output of number of RF-panorama scans.

Parameters:

none Current number of scans
MIN|MAX minimum/maximum number

Result:

Number of scans; 9.9E37 is output for an infinite number

Example:

PSCan:COUN? 100

**[SENSe]****. :PSCan****. . :DIRrection UP|DOWN**

Sets scan direction. This value is mapped onto the same variable as the frequency scan direction variable, meaning that a change affects both scan modes.

Parameters:

UP scan with increasing frequency

DOWN scan with decreasing frequency

Example:

PSCan:DIRrection DOWN

**[SENSe]****. :PSCan****. . :DIRrection?**

Query of scan direction. This command is an alias of SENS:SWE:DIR?.

Parameters:

none

Result:

UP, DOWN

Example:

PSCan:DIRrection? DOWN



[SENSe]

. :PSCan

. . :STEP <numeric_value>|UP|DOWN|MINimum|MAXimum

Sets the resolution of an RF-panorama scan. Essentially, it sets the channel-spacing of the FFT samples: i.e. the FFT-bin width.

Parameters:

<numeric_value> frequency spacing of FFT samples

UP|DOWN next/previous possible resolution

MIN|MAX set to narrowest|widest possible resolution

Example:

SENSe:PSCan:STEP 10 kHz



[SENSe]

. :PSCan

. . :STEP? [MINimum|MAXimum]

Output of current channel spacing for PSCan.

Parameters:

none Current bandwidth

MINimum Narrowest possible bandwidth

MAXimum Widest possible bandwidth

Result:

Bandwidth in Hz

Example:

SENSe:PSCan:STEP? 10000



```
[SENSe]
. :ROSCillator
. . :EXTernal
. . . :FREQuency?
```

Query of what the external reference frequency must be.

Parameters:

none

Result:

10000000

Example:

ROSCillator:EXTernal:FREQuency? -> 10000000



```
[SENSe]
. :ROSCillator
. . :INTernal
. . . :FREQuency?
```

Query of what the internal reference frequency must be.

Parameters:

none

Result:

10000000

Example:

ROSCillator:INTernal:FREQuency? -> 10000000

**[SENSe]****. :ROSCillator****. . :SOURce INTernal|EXTernal**

Setting whether external or internal reference frequency is to be used.

Parameters:

INTernal internal reference oscillator

EXTernal external reference oscillator

Example:

ROSCillator:SOURce EXTernal

**[SENSe]****. :ROSCillator****. . :SOURce?**

Query of reference oscillator to be used.

Parameters:

none

Result:

INT internal reference oscillator

EXT external reference oscillator

Example:

ROSCillator:SOURce? -> EXT

Sense Frequency Scan subsystem SWE

The SWEep system controls the frequency function of the device if the frequency scan has been activated by the SENSE:FREQUENCY:MODE SWEep command. Each scan is initiated by INITiate[:IMMEDIATE].



[SENSE]

```
. :SWEep
. . :CONTrol
. . . :OFF <control_function> {,<control_function>}
```

Command for switch-off of the STOP:SIGNalfunctions. See also SENS:SWE:CONT:ON. This value is mapped onto the same variable as the memory scan control mechanism variable, meaning that a change affects both scan modes.

Parameters:

<control_function> is the following string:
"STOP:SIGNal" switch-on signal-controlled dwell-time

*RST state:

after *RST, all control mechanisms are on

Example:

```
SWEep:CONTrol:OFF "STOP:SIGN"
```



[SENSE]

```
. :SWEep
. . :CONTrol
. . . :OFF?
```

Query of switched-off scan-control functions.

Parameters:

none

Result:

List of switched-off control functions. If no function is inactive, a zero string ("") is output. The following strings are to be expected:

```
"STOP:SIGN"      signal-controlled dwell-time switched off
""                zero string : no function is active
```

Example:

```
SWEep:CONTrol:OFF? -> "STOP:SIGN"
```



[SENSe]

```

. :SWEep
. . :CONTRol
. . . :[ON] <control_function> {,<control_function>}

```

Command for switch-on of the STOP:SIGNalfunctions. With "STOP:SIGNal" the disappearance of the signal during the dwell time signals the start of the hold-time. When either the hold-time or the dwell-time has elapsed, scanning continues. If the signal re-appears during the hold-time, the hold-time is aborted. The dwell-time though, never stopped and continues. The hold time after the disappearance of the signal is set with SENSE:SWEep:HOLD:TIME. This value is mapped onto the same variable as the memory scan control mechanism variable, meaning that a change affects both scan modes.

Parameters:

<control_function> is one of the following strings:

"STOP:SIGNal" switch-on signal-controlled dwell-time

***RST state:**

after *RST, all control mechanisms are on

Example:

```
SWEep:CONTRol "STOP:SIGN"
```

**[SENSe]**

```

. :SWEep
. . :CONTRol
. . . [:ON]?

```

Query of switched-on scan-control functions.

Parameters:

none

Result:

List of switched-on control functions. If no function is active, a zero string ("") is output. The following strings are to be expected:

"STOP:SIGN" signal-controlled dwell-time is switched on

"" zero string : no function is active

Example:

```
SWEep:CONTRol? -> "STOP:SIGN"
```



[SENSe]

. :SWEep

. . :COUNT <numeric_value>|MINimum|MAXimum|INFINITY

Sets the number of sweeps. This value is mapped onto the same variable as the memory scan and panorama scan count variable, meaning that a change affects all scan modes.

Parameters:

<numeric_value> number of sweeps

MINimum|MAXimum minimum|maximum number

INFINITY infinite number

Example:

SWEep:COUNT 100



[SENSe]

. :SWEep

. . :COUNT? [MINimum|MAXimum]

Query of number of sweeps.

Parameters:

none query of current number of sweeps

MINimum|MAXimum query of minimum|maximum sweeps

Result:

Number of sweeps; 9.9E37 is output for an infinite number

Example:

SWEep:COUNT? -> 100

**[SENSe]****. :SWEep****. . :DIRection UP|DOWN**

Setting the scan direction. This value is mapped onto the same variable as the memory scan direction variable, meaning that a change affects both scan modes.

Parameters:

UP scan with increasing frequency

DOWN scan with decreasing frequency

Example:

SWEep:DIRection DOWN

**[SENSe]****. :SWEep****. . :DIRection?**

Query of scan direction

Parameters:

none

Result:

UP, DOWN

Example:

SWEep:DIRection? -> DOWN



[SENSe]

. :SWEep

. . :DWELI <numeric_value>|MINimum|MAXimum|INFinity

Setting the dwell time. This value is mapped onto the same variable as the memory scan dwell time variable, meaning that a change affects both scan modes.

Parameters:

<numeric_value> dwell time in seconds
 MINimum|MAXimum lowest|highest dwell time
 INFinity infinite dwell time

Remark:

This command is used to set the dwell time per scan step, if the squelch is switched off.

Example:

SWEep:DWEL 100 ms



[SENSe]

. :SWEep

. . :DWELI? [MINimum|MAXimum]

Query of dwell time with hold criterion fulfilled.

Parameters:

none query of current dwell time
 MINimum|MAXimum query of lowest|highest dwell time

Result:

Dwell time in seconds; ; 9.9E37 is output for an infinite number.

Example:

SWEep:DWEL? 0.10



[SENSe]

. :SWEep
 . . :HOLD
 . . . :TIME <numeric_value>|MINimum|MAXimum

Setting the hold time for a signal-controlled scan continuation. If the signal disappears during the dwell time, the hold time is started. After completion of the hold time, the scan is continued with the next frequency even if the dwell time has not yet been completed. If the signal exceeds the squelch threshold during the hold time, the hold time is reset and the end of the dwell time or the renewed disappearance of the signal is awaited. The hold time is only used if the control function "STOP:SIGNal" (see SENSe:SWEep:CONTRol) is switched on.

Setting the time to 0 (zero) has the same effect as switching off the control function with SENS:SWE:CONT:OFF "STOP:SIGN".

This value is mapped onto the same variable as the memory scan hold time variable, meaning that a change affects both scan modes.

Parameters:

<numeric_value> hold time in seconds
 MINimum|MAXimum lowest|highest hold time

Example:

SWEep:HOLD:TIME 10 ms



[SENSe]

. :SWEep
 . . :HOLD
 . . . :TIME? [MINimum|MAXimum]

Query of hold time during signal-controlled scan continuation.

Parameters:

none query of current hold time
 MINimum|MAXimum query of lowest|highest hold time

Result:

Hold time in seconds

Example:

SWEep:HOLD:TIME? 0.010

**[SENSe]****. :SWEep****. . :STEP <numeric_value>|MINimum|MAXimum**

Setting the frequency stepwidth for the frequency scan.

Parameters:

<numeric_value> frequency value

MINimum|MAXimum setting the smallest/biggest frequency stepwidth

Example:

SWEep:STEP 25 kHz

**[SENSe]****. :SWEep****. . :STEP? [MINimum|MAXimum]**

Query of frequency stepwidth of a frequency scan.

Parameters:

none query of current frequency stepwidth

MINimum|MAXimum query of smallest|largest frequency stepwidth

Result:

Stepwidth in Hz

Example:

SWEep:STEP? -> 25000



[SENSe]

. :SWEep
 . . :SUPPress

Insert current frequency into suppress list. The range is obtained from the bandwidth according to the following formulae:

$$\begin{aligned} \text{SSTARTn} &= \text{SENSn:FREQ} - \text{SENSn:BAND}/2 \\ \text{SSTOPn} &= \text{SENSn:FREQ} + \text{SENSn:BAND}/2 \end{aligned}$$

The frequency pair is inserted into an empty space of the trace. Free spaces (gaps) are characterized by a frequency pair with each having the value 0 (zero).

Error:

If the corresponding suppress trace has no free space, an error -223 "Too much data" is generated.

Parameters:

none

Example:

SWEep:SUPPress



[SENSe]

. :SWEep
 . . :SUPPress
 . . . :SORT

Sort and condense suppress list. The frequency pairs are sorted in ascending order of the start frequency. Overlapping is eliminated by extending one frequency pair, and deleting the other. Gaps in the suppress list are put to the end of the list.

Parameters:

none

Example:

SWEep:SUPPress:SORT

11.15 STATus subsystem

The following extended STATus register commands are available:

```

STATus
. :EXTension
. . :CONDition?
. . :ENABLE <numeric_value>
. . :ENABLE?
. . [:EVENT]?
. . :NTRansition <numeric_value>
. . :NTRansition?

```

```

. . :PTRansition <numeric_value>
. . :PTRansition?
. :OPERation
. . :CONDition?
. . :ENABle <numeric_value>
. . :ENABle?
. . [:EVENT]?
. . :NTRansition <numeric_value>
. . :NTRansition?
. . :PTRansition <numeric_value>
. . :PTRansition?
. . :SWEeping
. . . :CONDition?
. . . :ENABle <numeric_value>
. . . :ENABle?
. . . [:EVENT]?
. . . :NTRansition <numeric_value>
. . . :NTRansition?
. . . :PTRansition <numeric_value>
. . . :PTRansition?
. :PREset
. :QUESTionable
. . :CONDition?
. . :ENABle <numeric_value>
. . :ENABle?
. . [:EVENT]?
. . :NTRansition <numeric_value>
. . :NTRansition?
. . :PTRansition <numeric_value>
. . :PTRansition?
. :TRACe
. . :CONDition?
. . :ENABle <numeric_value>
. . :ENABle?
. . [:EVENT]?
. . :NTRansition <numeric_value>
. . :NTRansition?
. . :PTRansition <numeric_value>
. . :PTRansition?

```

The commands of the STATus:OPERation register are explained below. The OPERation register is also used as example for the OPERation:SWEep, the QUESTionable, because these are handled in the same way.

STATus

```

. OPERation
. . :CONDition?

```

Query of the condition section of the OPERation status register.

Parameters:

none

Remark:

Leading zero's are not displayed.

Result:

The FORMat:SREGister command determines the output format.

Example:

STATus:OPERation:CONDition? -> #H8

STATus

- . OPERation
- . . :ENABLE <numeric_value>

Setting the enable section of the OPERation status register.

Parameters:

<numeric_value> value of the enable section
(e.g. 0..65535 or #H0..#HFFFF)

***RST state:**

will not be changed by *RST

Example:

STATus:OPERation:ENABLE #H8

STATus

- . OPERation
- . . :ENABLE?

Query of the enable section of the OPERation status register.

Parameters:

none

Remark:

Leading zero's are not displayed.

Result:

The FORMat:SREGister command determines the output format.

Example:

STATus:OPERation:ENABLE? -> #H8

STATus

- . OPERation
- . . [:EVENT]?

Query of the event section of the OPERation status register.

Parameters:

none

Result:

The FORMat:SREGister command determines the output format.

Example:

STATus:OPERation? -> #H8

STATus

- . **OPERation**
- . . **:NTRansition <numeric_value>**

Setting the negative transition filter of the OPERation status register.

Parameters:

<numeric_value> value of the NTRansition section
(e.g. 0..65535 or #H0..#HFFFF)

***RST state:**

will not be changed by *RST

Example:

STATus:OPERation:NTRansition #H0

STATus

- . **OPERation**
- . . **:NTRansition?**

Query of the negative transition filter of the OPERation status register.

Parameters:

none

Remark:

Leading zero's are not displayed.

Result:

The FORMat:SREGister command determines the output format.

Example:

STATus:OPERation:NTRansition? -> 0

STATus

- . **OPERation**
- . . **:PTRansition <numeric_value>**

Setting the positive transition filter of the OPERation status register.

Parameters:

<numeric_value> value of the PTRansition section
(e.g. 0..65535 or #H0..#HFFFF)

***RST state:**

will not be changed by *RST

Example:

STATus:OPERation:PTRansition #B1111111111111111

STATus

. **OPERation**

. . **:PTRansition?**

Query of the positive transition filter of the OPERation status register.

Parameters:

none

Remark:

Leading zero's are not displayed.

Result:

The FORMat:SREGister command determines the output format.

Example:

STATus:OPERation:PTRansition? -> 255

STATus

. :PRESet

Setting the STATus registers with default values according to:

| Register | ENABLE/PTR/NTR | PRESet value |
|-------------------------|----------------------|---------------------|
| STATus:OPERational | ENABLE PTR NTR | 0 65535 0 |
| STATus:QUEStionable | ENABLE PTR NTR | 0 65535 0 |
| STATus:TRACe | ENABLE PTR NTR | 65535 65535 0 |
| STATus:EXTension | ENABLE PTR NTR | 65535 65535 0 |
| STATus:OPERation:SW Eep | ENABLE PTR NTR | 65535 65535 0 |

Parameters:

none

Example:

STATus:PRESet

STATus

. :QUEue?

. . [:NEXT]?

Reads the next entry from the Error Queue. This is an alias of SYST:ERR?

Parameters:

none

Result:

Next entry of Error Queue

Example:

STATus:QUEue? -> 0, "No error"

11.16 SYSTem subsystem

SYSTem**. :AUDio****. . :BALance <numeric_value>|MINimum|MAXimum**

Sets the balance of AF for the headphones.

Parameters:

<numeric_value> balance of AF from -0.5 to +0.5

-0.50 = only left channel

0.00 = mid position

0.50 = only right channel

MINimum|MAXimum only left AF channel | only right AF channel

Example:

SYSTem:AUDio:BALance 0.5

SYSTem**. :AUDio****. . :BALance? MINimum|MAXimum**

Query of AF balance.

Parameters:

none

MINimum|MAXimum min. | max. value

Result:

Audio balance

Example:

SYSTem:AUDio:BALance? -> 0.50

SYSTem

. :AUDio
 . . :OUTPut AUTO|HPHone

Switches between automatic selection of the audio output (via the speaker or via the headphone), or always output via the headphone.

Parameters:

AUTO Output is directed to a headphone when it is connected, and to the speaker otherwise

HPHone Output is always directed to a headphone

Example:

SYSTem:AUDio:OUTPut HPHone

SYSTem

. :AUDio
 . . :OUTPut?

Query of audio output selection.

Parameters:

none

Result:

AUTO, HPH

Example:

SYSTem:AUDio:OUTPut? -> HPH

SYSTem

. :AUDio
 . . :VOLume <numeric_value>|MINimum|MAXimum

Sets the volume of AF for loudspeakers and headphones.

Parameters:

<numeric_value> volume of AF from 0 to 1

0.00 = no AF

1.00 = full volume of AF

MINimum|MAXimum no AF | full volume of AF

Remark:

The parameter is rounded to the next internally settable discrete value.

Example:

SYSTem:AUDio:VOLume 0.50

SYSTem

. :AUDio
. . :VOLume? [MINimum|MAXimum]

Query of AF volume.

Parameters:

none
MINimum|MAXimum min. | max. volume

Result:

Audio volume

Example:

SYSTem:AUDio:VOLume? -> 0.50

SYSTem

. :BEEPer
. . :VOLume <numeric_value>|MINimum|MAXimum

Sets the volume of the beeper.

Parameters:

<numeric_value> volume of beeper from 0 to 1
 0.00 = beeper off
 1.00 = beeper at maximum volume
MINimum|MAXimum beeper off|beeper on

Example:

SYSTem:BEEPer:VOLume 0.50

SYSTem

. :BEEPer
. . :VOLume? [MINimum|MAXimum]

Query of volume of beeper.

Parameters:

none
MINimum|MAXimum min. | max. volume

Result:

Beeper volume

Example:

SYSTem:BEEPer:VOLume? -> 0.50

SYSTem

- . :COMMunicate
- . . :GPIB
- . . . :SELF
- :RTERmintator EOI

This command is only provided to remain compatible with specific R&S tools that send this command. It does nothing, but does not return an error either.

Parameters:

EOI

Example:

SYSTem:COMMunicate:GPIB:SELF:RTER EOI

SYSTem

- . :COMMunicate
- . . :LAN
- . . . :ETHernet?

Produces the MAC address of the ethernet interface

Parameters:

none

Result:

Ethernet address, 6 bytes in hexadecimal notation

Remark:

When no ethernet interface is available, the result is: "00-00-00-00-00-00"

Example:

SYSTem:COMMunicate:LAN:ETHernet? -> "A1-B2-C3-D4-E5-F6"

SYSTem

. :COMMunicate
. . :LAN
. . . :SUBMask <ip-address>

Sets the subnet mask of all IP communication. Note that setting this to another subnet might result in losing connection with the device. Therefore, it is most convenient to change all communication settings on the same line. The settings will not take effect until the new-line has been received.

Parameters:

<ip-address> string representing IP dot notation of IP address (e.g. "255.255.255.0")

The ip-address must be a valid subnet mask according to IP specifications.

Error:

In case the subnet mask is invalid, an execution error -200,"Execution error" is generated.

***RST state:**

The mask is maintained after reset

Example:

SYSTem:COMMunicate:LAN:SUBMask "255.255.255.0"

SYSTem

. :COMMunicate
. . :LAN
. . . :SUBMask?

Query the subnet mask

Parameter:

none

Result:

string representing IP dot notation of IP subnet mask (e.g. "255.255.255.0")

Example:

SYSTem:COMMunicate:LAN:SUBMask? -> "255.255.255.0"

SYSTem

. :COMMunicate
. . :SOCKet
. . . :ADDRess <ip-address>

Sets the IP-address of the ethernet connection of the device. Note that setting this to another address results in losing connection with the device. Therefore, it is most convenient to change all communication settings on the same line. The settings will not take effect until the new-line has been received. This only changes the address of the ethernet connection, it does not influence the USB connection.

Parameters:

<ip-address> string representing IP dot notation of IP address (e.g. "172.17.75.18")

Error:

In case the IP address is invalid, an execution error -200, "Execution error" is generated.

***RST state:**

The address is maintained after reset

Example:

SYSTem:COMMunicate:SOCKET:ADDRess "172.17.75.18"

SYSTem

. :COMMunicate
. . :SOCKet
. . . :ADDRess?

Query the IP-address of the device

Parameter:

none

Result:

string representing IP dot notation of IP address (e.g. "172.17.75.18")

Example:

SYSTem:COMMunicate:SOCKET:ADDRess? -> "172.17.75.18"

SYSTem

. :COMMunicate
. . :SOCKet
. . . :DHCP
. . . . [:STATe] <Boolean>

Determines whether the IP address is set automatically by the DHCP protocol.

Parameters:

ON Turn DHCP on (IP address determined by DHCP server in network)
OFF Turn DHCP on (IP address must be set manually)

Example:

SYSTem:COMMunicate:SOCKET:DHCP:STATe ON

SYSTem

. :COMMunicate
. . :SOCKet
. . . :DHCP
. . . . [:STATe]?

Query state of DHCP.

Parameter:

none

Result:

0, 1

Example:

SYSTem:COMMunicate:SOCKET:DHCP:STATe? -> 1

SYSTem

. :COMMunicate
. . :SOCKet
. . . :PORT <numeric_value>

Sets the IP-port number of the SCPI parser. Note that setting this to another address results in losing connection with the device. Therefore, it is most convenient to change all communication settings on the same line. The settings will not take effect until the new-line has been received.

Parameters:

<numeric_value> integer port number in the range [0,65535] (16 bit)

Error:

In case the port number is invalid, an execution error -200, "Execution error" is generated.

***RST state:**

The port number is maintained after reset

Example:

SYSTem:COMMunicate:SOCKet:PORT 5555

SYSTem

. :COMMunicate
. . :SOCKet
. . . :PORT?

Query the IP-port number of the SCPI parser

Parameter:

none

Result:

integer port number in the range [0,65535] (16 bit)

Example:

SYSTem:COMMunicate:SOCKet:PORT? -> 5555

SYSTem

. :DATE <year>, <month>, <day>

Sets the current date for the device

Parameters:

<year> integer number in the range [2000-2099]
<month> integer number in the range [1,12] (1 = January, 12 =
December)
<day> integer number in the range [1,31]

Error:

In case the date is invalid, an execution error -200, "Execution error" is generated.

***RST state:**

The date is maintained after reset

Example:

SYSTem:DATE 2008, 12, 21

SYSTem

. :DATE?

Query the current date of the device

Parameter:

none

Result:

<year>, <month>, <day> (see SYST:DATE)

Example:

SYSTem:DATE? -> 2008, 12, 21

SYSTem

. :ERRor
. . [:NEXT]?

Returns the error code and description of the error at the front of the queue. The error is also removed from the queue.

Parameters:

none

Result:

Next entry of Error Queue. If the Error Queue is empty, 0, "No error" is output

Example:

SYSTem:ERRor? -> 0, "No error"

SYSTem

. :ERRor
. . :ALL?

Returns all error codes and descriptions from the Error Queue. The queue is emptied.

Parameters:

none

Result:

Comma-separated list of error-codes and strings. If the Error Queue is empty, 0, "No Error" is output

Example:

SYSTem:ERRor:ALL? -> -292, "Referenced name does not exist", -293, "Referenced name already exists"

SYSTem

. :ERRor
. . :CODE
. . . [:NEXT]?

Returns just the error code of the error at the front of the queue. The error is also removed from the queue.

Parameters:

none

Result:

Error code. If the Error Queue is empty, 0, "No error" is output

Example:

SYSTem:ERRor:CODE? -> 0

SYSTem

. :ERRor
. . :CODE
. . . :ALL?

Returns just the error codes of all errors in the queue, and empties the queue.

Parameters:

none

Result:

Comma-separated list of error codes. If the Error Queue is empty, 0 is output

Example:

SYSTem:ERRor:CODE:ALL? -> -292, -293

SYSTem

. ERRor
. . :COUNT?

Returns the number of error messages in the queue. The queue is not emptied.

Parameters:

none

Result:

Number of errors in the queue

Example:

SYSTem:ERRor:COUNT? -> 0

SYSTem**. :FIRMware****. . :UPDate**

This command will update the firmware of the instrumen.

Remark:

The instrument will look for a new firmware version on the SD-Card. If correct firmware is found, than the firmware will be installed without any user-confirmation.

Parameters:

none

Example:

SYSTem:FIRMware:UPDate

SYSTem

- . :KCLick
- . . :VOLume <numeric_value>|MINimum|MAXimum

Sets the volume of the key clicks.

Parameters:

<numeric_value> volume of beeper from 0 to 1
0 = key clicks off
1 = key clicks at maximum volume
MINimum|MAXimum beeper off|beeper on

Example:

SYSTem:KCLick:VOLume 0.5

SYSTem

- . :KCLick
- . . :VOLume? [MINimum|MAXimum]

Query of volume of key clicks.

Parameters:

none
MINimum|MAXimum min. | max. volume

Result:

Key-click volume

Example:

SYSTem:KCLick:VOLume? -> 0.50

SYSTem**. :PRESet****. . :FACTory**

Resets the device to factory settings by executing the command sequence:

- *RST
- STATus:PRESet

followed by resetting the following settings:

- IP Subnet mask (see SYST:COMM:LAN:SUBM)
- IP Address (see SYST:COMM:SOCK:ADDR)
- IP Port (see SYST:COMM:SOCK:PORT)
- DHCP state (see SYST:COMM:SOCK:DHCP:STAT)
- Clear memory lists: MEM:CLE 0, MAX
- Clear antenna lists:ROUT:PATH:DEL:ALL
- Clear suppress lists: TRAC:DATA SSTART, 0; TRAC:DATA SSTOP, 0
- Clear presets: PROG:PRES:DEL:ALL
- Clear UDP addresses: TRAC:UDP:DEL ALL
- Clear traces

Note that the security and password settings (SYST:SEC and SYST:PASS subsystems) are not reset. Any device specific behaviour is described under this same command in the specific documentation.

Parameters:

None

Example:

SYSTem:PRESet:FACTory

SYSTem**. :PRESet****. . :MEASurements**

Reset only measurement related settings of the device.

Parameters:

None

Example:

SYSTem:PRESet:MEASurements

SYSTem**. :SECurity****. . :OPTion <code>**

A special optional firmware can be activated by entering a certain option code. The unit must be switched on anew to activate this optional software. For a list of possible options, see the common command “*OPT?”.

Remark:

The SCPI interface itself is also an option. If this option is not active, none of the commands in this interface work. However, this command is an exception. When the SCPI option is not active, this command can be used to activate it. Note that no error reports can be retrieved via “SYST:ERR?”, and none of the other options can be activated as long as the SCPI option is not active.

Parameters:

<code> 8-digit number

Error codes:

-220 Parameter error incase optionkey is incorrect.

***RST state:**

The options are maintained after a reset.

Example:

SYSTem:SECurity:OPTion "12345678"

SYSTem**. :TIME <hours>, <minutes>, <seconds>**

Sets the current time for the device

Parameters:

<hours> integer number in the range [0:23]

<minutes> integer number in the range [0:59]

<seconds> any number in the range [0:60]

The seconds are specified by a real number that is rounded toward the resolution of the device's internal clock accuracy. The number 60 is allowed here, because rounding can yield a number larger than 59.5.

Error:

In case the time is invalid, an execution error -200, "Execution error" is generated.

***RST state:**

The time is maintained after reset

Example:

```
SYSTem:TIME 15, 17, 01.876
```

SYSTem**. :TIME?**

Query the current time of the device

Parameter:

none

Result:

<hours>, <minutes>, <seconds> (see SYST:TIME)

Example:

```
SYSTem:TIME? -> 15, 20, 31.546
```

SYSTem**. :VERSion?**

Query of SCPI standard used by the device.

Parameters:

none

Result:

Version in format YYYY.V, where YYYY stands for the corresponding version year and V for the corresponding revision number of this year.

Example:

SYSTem:VERSion? -> 2008.1

11.17 TRACe|DATA subsystem

Instead of the command word TRACe, DATA can also be used. Traces are used for summarizing data. Several predefined traces are available. Each one is described below.

Result Traces: MTRACE, ITRACE

For the results, two predefined traces (MTRACE = Measurement Trace and ITRACE = Information Trace) are available. They cannot be deleted. MTRACE receives its data from the SENSE:FUNCTion block. All sensor functions switched on deliver their measured values to the MTRACE where they are stored. ITRACE receives its data from the SENSE:FREQUENCY block. In addition to the current receiver frequency the corresponding channel number is also stored. The start command to initiate measurement (INITiate[:IMMEDIATE]) clears the MTRACE (or ITRACE) data set. Via the control instruction (TRAC:FEED:CONT), a condition can be defined that selects the data to be written into the MTRACE or ITRACE. If the control conditions of the two traces are identical, each TRACE value has a corresponding information value in the ITRACE. When the maximum data set length is attained, MTRACE and ITRACE are closed down. Any subsequent data are thus lost.

In the status reporting system the state of this traces is available in the status bits (see Section 9.2.1.6).

IF Panorama Trace: IFPAN

The command TRACe:FEED:CONTrol IFPAN, ALWays starts loading of the IFPAN Trace. The command DISPlay:MENU IFPAN starts the IF panorama, and the data levels are output. The spectrum length depends on the bandwidth chosen. The current number of pixels can be queried by the command TRACe:POINTs? IFPAN

In the status reporting system the state of this traces is available in the status bits (see Section 9.2.1.6).

Suppress Traces: SSTART, SSTOP

Suppress lists are stored as two predefined traces, SSTART (= Suppress START) and SSTOP (=Suppress STOP). The suppress list has 100 elements with each element consisting of two frequencies. The frequency pair specifies a frequency range which is suppressed during the scan. It is irrelevant that the 1st frequency is lower than the 2nd frequency. The sequence in the list is irrelevant, too. Gaps are specified by the frequency pair 0.0. If one frequency of the frequency pair is 0, the other frequency of the pair is seen as a single frequency.

Examples:

| 1 st Frequency | 2 nd Frequency | Description |
|---------------------------|---------------------------|---|
| 118000000 | 136000000 | Suppression of range 118 to 136 MHz |
| 98550000 | 98450000 | Suppression of range 98,450 to 98,550 MHz |
| 0 | 0 | Empty frequency pair (irrelevant) |
| 118375000 | 0 | Suppress single frequency 118,375 MHz |
| 0 | 123400000 | Suppress single frequency 123,400 MHz |
| 127675000 | 127675000 | Suppress single frequency 127,675 MHz |

When retrieving the above list via the two queries "TRAC:DATA? SSTART" and "TRAC:DATA? SSTOP", the list is slightly corrected: All single frequencies get the same frequency value in the SSTART and the SSTOP list. Clearing the suppress lists must always include both commands (TRAC SSTART, 0; TRAC SSTOP, 0).

| 1 st Frequency | 2 nd Frequency |
|---------------------------|---------------------------|
| 118000000 | 136000000 |
| 98450000 | 98550000 |
| 0 | 0 |
| 118375000 | 118375000 |
| 123400000 | 123400000 |
| 127675000 | 127675000 |

In the status reporting system the state of this traces is available in the status bits (see Section 9.2.1.6).



TRACe|DATA

. :CATalog?

Query of all defined trace names

Parameters:

none

Result:

"MTRACE", "ITRACE", "IFPAN", "SSTART", "SSTOP", "UDP"



TRACe|DATA

. [:DATA] <trace_name>, <numeric_value> {, <numeric_value>} |
<block>

Writing data to a trace. Existing data is lost.

Remark:

Only the suppress traces can be written to.

Error:

If the trace name is unknown or not identical with a suppress trace, error -141 "Invalid character data" is generated. If too many data are loaded in a suppress trace, error -223 "Too much data" is generated.

Parameter:

<trace-name> name of the trace to be written to
Note: These are not strings but predefined keywords. I.e.:
They cannot be included in quotes.

<numeric_value> list of frequencies. If the list is not complete, the rest of
the trace is filled with 0.

Note: In contrast to the SCPI standard a single value is
not used for the complete trace!

<block> As an alternative to the frequency list a <Definite
Length Block> can be transmitted
with the following structure: Frequency list with frequencies in Hz, 8 bytes per
frequency.

*RST state:

No change of trace contents at *RST.

Example:

TRACe SSTART, 123.475 MHz, 118000000, 98550 kHz

**TRACe|DATA**

. [:DATA]? <trace_name>

Query of trace data. After the query, the trace is cleared, except for the SSTART and SSTOP traces.

Parameters:

<trace_name> name of desired trace (MTRACE, ITRACE, IFPAN or SSTART, SSTOP)

Error:

If the trace name is unknown, an error -141, "Invalid character data" will be generated.

Result:

The output format is defined by the FORM:DATA command:

ASCii normal ASCII output

PACKEd Block Data, see [Orion SCPI].

The possible data-types that can be output are listed below:

| Data Type | C Data-Type | Description |
|--------------------|--------------------|-------------------------------------|
| "VOLTage:AC" | signed short | level in 1/10 dB μ V |
| "FREQuency:OFFSet" | signed long | offset in Hz |
| "FSTRength" | signed short | field strength in 1/10 dB μ V/m |
| Channel Number | unsigned short | channel number |
| Frequency | unsigned long long | frequency in Hz |

What data and in what order belong to a trace, is specified for each trace separately:

MTRACE

Output of measured values of all sensor functions switched on. If no function is switched on, NaN (Not a Number) is output. The INF value 9.9E37 is entered into the result buffers MTRACE and ITRACE to mark the end of the trace.

1. "VOLTage:AC" (if the associated function is switched on via SENS:FUNC:ON)
2. "FREQUency:OFFSet" (if the associated function is switched on via SENS:FUNC:ON)
3. "FSTRength" (if the associated function is switched on via SENS:FUNC:ON)

The end of each sweep (if SENS:SWE:CNT is set to 10, then there are 10 sweeps in a scan) is marked by the values 2000 for "VOLTage:AC" and 0 for Frequency.

ITRACE

1. Channel Number
2. Frequency

The end of each sweep (if SENS:SWE:CNT is set to 10, then there are 10 sweeps in a scan) is marked by the value 0 for Frequency.

IFPAN

If there are no data available then a NaN (Not a Number) will be output.

1. "VOLTage:AC"

Suppress Traces

Output the list of frequencies contained in the trace.

1. Frequency

Remark:

INF (range limit flag) will be coded in the PACKed format as follows:

- INF level = 2000
- INF offset = 10000000
- INF FSTR = 0x7FFF
- INF freq = 0
- INF channel = 0

NINF (no measurement possible) will be coded in the PACKed format as follows:

- NINF offset = 10000000-1
- NINF FSTR = 0x7FFE
- NINF AM = 0x7FFE
- NINF FM = 0x7FFF FFFE
- NINF PM = 0x7FFE
- NINF BW = 0x7FFF FFFE

NaN is output as #110 in the PACKed format

To ensure that for the two traces MTRACE and ITRACE the same number of points is output, the two queries have to be one directly behind the other on the same command line (e.g. "TRACE? MTRACE;TRACE? ITRACE").

Example:

TRACe? MTRACE -> 23.4, -2500, 18.5, 1500

TRACE? SSTART -> 123475000, 118000000, 98550000, 0, 0, 0,

**TRACe|DATA**

. :FEED? <trace_name>

Query of data block connected with the trace. Does not apply to SSTART and SSTOP traces.

Parameters:

<trace_name> see TRACe[:DATA]?

Error:

If the trace name is unknown, an error -141, "Invalid character data" will be generated.

Result:

Name of the block coupled to the trace.

MTRACE: "SENS"

ITRACE: "FREQ"

IFPAN: "SENS"

Example:

TRACe:FEED? MTRACE -> "SENS"



TRACe|DATA

. :FEED

. . :CONTRol <trace_name>, ALWays|SQUelch|NEVer

Determines how a trace is loaded with data. Data are always added to a trace; i.e. the trace is not emptied first (see also TRAC:FEED:CONT:RECM). To empty a trace, it must be read with TRACe?

Parameters:

<trace-name> see TRACe[:DATA]?

ALWays each measurement is stored in the trace. This starts recording.

SQUelch data are first stored, if the signal has exceeded the squelch threshold defined in the

OUTPut:SQUelch subsystem. This starts recording.

NEVer do not store any data in the trace. This stops recording.

Remark:

For IFPAN Trace, only ALWays or NEVer can be selected.

Error:

If trace name is unknown, an error -141, "Invalid character data" will be generated.

*RST state:

NEVer

Example:

TRACe:FEED:CONTRol MTRACE, ALWays



TRACe|DATA

. :FEED

. . :CONTRol? <trace_name>

Query of how a trace is loaded with data.

Parameters:

<trace_name> see TRACe[:DATA]?

Error:

If the trace name is unknown, an error -141, "Invalid character data" will be generated.

Result:

ALW, SQU, NEV

Example:

TRACe:FEED:CONTRol? MTRACE -> ALW

TRACe|DATA

. :LIMit

. . [:UPPer] <trace_name>, <numeric_value>|MINimum|MAXimum

Setting the limit of a trace. If the limit is exceeded, the Limit exceeded Flag will be set in the STATus:TRACe register.

Parameters:

<trace_name> see TRACe[:DATA]?

<numeric_value> limit in percentage of the maximum trace length

MINimum|MAXimum setting the least|greatest limit

Error:

If the trace name is unknown, an error -141, "Invalid character data" will be generated.

***RST state:**

50 PCT

Example:

TRACe:LIMit MTRACE, 50 PCT

▶

TRACe|DATA

. :LIMit

. . [:UPPer]? <trace_name>[,MINimum|MAXimum]

Query of trace limit

Parameters:

<trace_name> see TRACe[:DATA]?

no further parameter query of current limit

MINimum|MAXimum query of least|greatest limit

Error:

If the trace name is unknown, an error -141, "Invalid character data" will be generated.

Result:

Limit in percent

Example:

TRACe:LIMit? MTRACE -> 50



TRACe|DATA

. :POINts? <trace_name>[,MINimum|MAXimum]

Query of number of values stored in a trace. The number of values stored in the suppress traces is always 100. Thus, the MAXimum and MINimum value is also 100.

Parameters:

| | |
|----------------------|--------------------------------|
| <trace_name> | see TRACe[:DATA]? |
| no further parameter | query of current number |
| MINimum MAXimum | query of lowest highest number |

Error:

If the trace name is unknown, an error -141, "Invalid character data" will be generated.

Result:

Number of values

Example:

TRACe:POINts? MTRACE, MAX -> 2048



TRACe|DATA

. :POINts

. . :AUTO? <trace_name>

Query of auto-adjust of trace length. This command is present to remain backward compatible. A 0 (no auto-adjust for trace length) is always output for a suppress trace, and a 1 (auto-adjust) for other traces.

Parameters:

| | |
|--------------|-------------------|
| <trace_name> | see TRACe[:DATA]? |
|--------------|-------------------|

Error:

If the trace name is unknown, an error -141, "Invalid character data" will be generated.

Result:

| | |
|---|---------------------------------|
| 0 | no auto-adjust for trace length |
| 1 | auto-adjust for trace length |

Example:

TRACe:POINts:AUTO? MTRACE;AUTO? ITRACE -> 1;1



TRACe|DATA

- . :SUPPress
- . . :CONFig
- . . . :CATalog?

Outputs the name of the frequency suppress-list. This name can only be modified by uploading another configuration via the TRACe:SUPP:CONFig command.

Parameter:

none

Result:

Name of suppress list files, in a format identical to that of MMEM:CAT? (see [Orion SCPI]).

Example:

```
TRACe:SUPP:CONFig:CATalog? ->
3000, 120000000
Default, .suplst, 600, 00-00-0000, 00:00:00
```



TRACe|DATA

- . :SUPPress
- . . :CONFig <block_data>

Upload and activate a frequency suppress-list.

Parameters:

<block_data> block data with frequency suppress-list

Example:

```
TRACe:SUPP:CONFig <block-data specific for frequency suppress-list >
```



TRACe|DATA
. **:SUPPress**
. **. : CONFig?**

Outputs the frequency suppress-list as block data.

Parameters:

none

Result:

<block_data> of file contents

Example:

TRACe:SUPP:CONFig? -> <block-data specific for frequency suppress-list >



TRACe|DATA

. :VALue <trace_name>, <index>, <numeric_value>

Setting an element of a trace.

Parameters:

<trace_name> name of the trace, only SSTART and SSTOP are allowed

<index> Index of the element within the trace that is to be set.

The first element of a trace has the index 0.

<numeric_value> frequency value of the element

Remark:

Only suppress traces can be set.

Error:

If the trace name is unknown or not equal to a suppress trace name, an error - 141, "Invalid character data" is generated.

*RST state:

see TRACe:DATA

Example:

TRACe:VALue SSTART, 13, 98.550 MHz



TRACe|DATA

. :VALue? <trace_name>, <index>

Query of an element of a trace.

Parameters:

<trace_name> name of the trace

<index> Index of the element within the trace that is to be set.

The first element of a trace has the index 0.

Remark:

Only elements of the suppress traces can be queried.

Error:

If the trace name is unknown or not equal to a suppress trace name, an error - 141 "Invalid character data " is generated.

Result:

Frequency value of the element of a trace in Hz

Example:

TRACe:Value? SSTART, 13 -> 98550000.000000

11.18 TRACe|DATA:UDP subsystem

This sub-system controls what trace data are sent over UDP to a remote client. Each destination to which UDP data can be sent is called a UDP-address (which is equivalent to an IP address and port number). This sub-system keeps a list of all UDP-addresses that are used. The first item in this list is the default UDP-address, which is always present, and is retained after a power down and up.

For a description of how trace data are sent over UDP see Chapter 12.



TRACe|DATA

. :UDP? [<numeric_value>|MINimum|MAXimum|DEFault]

Query of available UDP-addresses and flags and tags that are set by the user. See Table 19 for tags and Table 20 for flags in Section 12.1.. Note that there are no predefined UDP-addresses. Each one must be entered by the user via a TRAC:UDP[:DEF]:TAG:ON and TRAC:UDP[:DEF]:FLAG:ON command.

Parameters:

| | |
|-----------------|---|
| none | lists all UDP addresses as in TRACe:UDP? |
| <numeric_value> | each on a new line |
| <numeric_value> | integer in the range [MIN, MAX] |
| MINimum | minimum index in the list of UDP-addresses (always 0) |
| MAXimum | maximum index in the list of UDP-addresses |
| DEFault | returns the index of the default UDP-address (always 0) |

Result:

DEF|<numeric_value> [<ip-address>, <ip-port> {, tag } {, flag }]

Example:

TRACe:UDP? MAX -> 3

TRACe:UDP? DEF -> 0

TRACe:UDP? 0 -> DEF

This means that the default UDP address has not yet been defined.

TRACe:UDP? 0 -> DEF "123.456.789.012", 5555, FSC, MSC, "FSTRength"

This means that field strength data is output in F-scan and M-scan data packets to port 5555 on IP address "123.456.789.012".

TRACe:UDP? 3 -> 003 "012.123.456.789", 4444, FSC, MSC, "VOLTage:AC"

This means that received-level data is output in F-scan and M-scan data packets to port 4444 on IP address "012.123.456.789".



TRACe|DATA

```
. :UDP
. . :DEFault
. . . :FLAG
. . . . :OFF <ip-address> , <ip-port> , <flag> {, <flag>}
```

Changes the UDP-address of the default address and removes the specified flags if present.

Parameters:

<ip-address> string representing IP dot notation of IP address (e.g. 172.17.75.18)
 <numeric_value> integer port number in the range [0,65535] (16 bit)
 <flag> See Table 20 for flags in Section 12.1.

*RST state:

The “*RST” command has no effect on these settings.

After a power down, the UDP-address list only contains the default entry (index 0). The default is retained.

Example:

```
TRACe:UDP:DEFault:FLAG:OFF "123.456.789.012", 5555, "VOLT:AC",
"SWAP"
```



TRACe|DATA

```
. :UDP
. . :DEFault
. . . :FLAG
. . . . [:ON] <ip-address> , <ip-port> , <flag> {, <flag>}
```

Changes the UDP-address of the default address and adds the specified flags that determine what data is included in traces. In case a flag is added to the default address that has tags that are incompatible with this flag (e.g. “FSTRength” flag and AUDio tag), these flags are ignored for those tags.

Parameters:

<ip-address> string representing IP dot notation of IP address (e.g. 172.17.75.18)
 <numeric_value> integer port number in the range [0,65535] (16 bit)
 <flag> See Table 20 for flags in Section 12.1.

*RST state:

The “*RST” command has no effect on these settings.

After a power down, the UDP-address list only contains the default entry (index 0). The default is retained.

Example:

```
TRACe:UDP:DEFault:FLAG:ON "123.456.789.012", 5555, "VOLT:AC",
"SWAP"
```

**TRACe|DATA****. :UDP****. . :DEFault****. . . :TAG****. . . . :OFF <ip-address> , <ip-port> , <tag> {, <tag>}**

Changes the UDP-address of the default address and removes the specified tags if present.

Parameters:

<ip-address> string representing IP dot notation of IP address (e.g. 172.17.75.18)

<numeric_value> integer port number in the range [0,65535] (16 bit)

<tag> See Table 19 for tag in Section 12.1.

***RST state:**

The “*RST” command has no effect on these settings.

After a power down, the UDP-address list only contains the default entry (index 0). The default is retained.

Example:

TRACe:UDP:DEFault:TAG:OFF “123.456.789.012”, 5555, MSC, FSC



TRACe|DATA

```
. :UDP
. . :DEFault
. . . :TAG
. . . . [:ON] <ip-address> , <ip-port> , <tag> {, <tag>}
```

Changes the UDP-address of the default address and adds the specified tags that determine what data is included in traces. In case a tag is added to the default address that has flags that are incompatible with this tag (e.g. “FSTRength” flag and AUDio tag), these flags are ignored for those tags. All tags and flags are off by default, but specifying the IFPan tag automatically includes the flag “VOLTage:AC”.

Parameters:

<ip-address> string representing IP dot notation of IP address (e.g. 172.17.75.18)
 <numeric_value> integer port number in the range [0,65535] (16 bit)
 <tag> See Table 19 for tag in Section 12.1.

*RST state:

The “*RST” command has no effect on these settings.
 After a power down, the UDP-address list only contains the default entry (index 0). The default is retained.

Example:

```
TRACe:UDP:DEFault:TAG:ON "123.456.789.012", 5555, MSC, FSC
```



TRACe|DATA

```
. :UDP
. . :DELeTe ALL| (<ip-address>, <ip-port>)
```

Deletes one UDP-addresses from the list, or all of them including the default one (index 0).

Parameters:

ALL All UDP-addresses are deleted, including the default one (index 0)
 <ip-address>, <ip-port> The UDP-address that matches the IP address and the port is deleted.

*RST state:

none, as command is an event

Example:

```
TRACe:UDP:DELeTe ALL
TRACe:UDP:DELeTe "012.123.456.789", 4444
```

**TRACe|DATA**

. :UDP

. . :FLAG

. . . :OFF <ip-address> , <ip-port>, <flag> {, <flag>...}

Sets a UDP-address and removes the specified flags if present. If the maximum number of UDP addresses (TRACe:UDP? MAX) has been reached an error is generated: -310, "Maximum number of UDP addresses exceeded".

Parameters:

<ip-address> string representing IP dot notation of IP address (e.g. 172.17.75.18)

<numeric_value> integer port number in the range [0,65535] (16 bit)

<flag> See Table 20 for flags in Section 12.1.

Remark:

If the UDP-address is not in the list, it is added to it. Otherwise, it is modified.

***RST state:**

The "*RST" command has no effect on these settings.

After a power down, the UDP-address list only contains the default entry (index 0). The default is retained.

Example:

TRACe:UDP:FLAG:OFF "123.456.789.012", 5555, "VOLT:AC", "SWAP"



TRACe|DATA

. :UDP

. . :FLAG

. . . [:ON] <ip-address> , <ip-port>, <flag> {, <flag>...}

Sets a UDP-address and adds the specified flags that determine what data is included in traces. If the maximum number of UDP addresses (TRACe:UDP? MAX) has been reached an error is generated: -310, "Maximum number of UDP addresses exceeded".

In case a flag is added to a UDP address that has tags that are incompatible with this flag (e.g. "FSTRength" flag and AUDio tag), these flags are ignored for those tags.

All tags and flags are off by default, but specifying the IFPan tag automatically includes the flag "VOLTage:AC".

Parameters:

| | |
|-----------------|---|
| <ip-address> | string representing IP dot notation of IP address (e.g. 172.17.75.18) |
| <numeric_value> | integer port number in the range [0,65535] (16 bit) |
| <flag> | See Table 20 for flags in Section 12.1. |

Remark:

If the UDP-address is not in the list, it is added to it. Otherwise, it is modified

*RST state:

The "*RST" command has no effect on these settings.

After a power down, the UDP-address list only contains the default entry (index 0). The default is retained.

Example:

TRACe:UDP:FLAG:ON "123.456.789.012", 5555, "VOLT:AC", "SWAP"



TRACe|DATA

. :UDP

. . :TAG

. . . :OFF <ip-address> , <ip-port>, <tag> {, <tag>...}

Sets a UDP-address and removes the specified tags if present. If the maximum number of UDP addresses (TRACe:UDP? MAX) has been reached an error is generated: -310, "Maximum number of UDP addresses exceeded".

Parameters:

<ip-address> string representing IP dot notation of IP address (e.g. 172.17.75.18)

<numeric_value> integer port number in the range [0,65535] (16 bit)

<tag> See Table 19 for tags in Section 12.1.

Remark:

If the UDP-address is not in the list, it is added to it. Otherwise, it is modified

*RST state:

The "*RST" command has no effect on these settings.

After a power down, the UDP-address list only contains the default entry (index 0). The default is retained.

Example:

TRACe:UDP:TAG:OFF "123.456.789.012", 5555, MSC, FSC



TRACe|DATA

```
. :UDP
. . :TAG
. . . [:ON] <ip-address> , <ip-port>, <tag> {, <tag>...}
```

Sets a UDP-address and adds the specified tags that determine what data is included in traces. If the maximum number of UDP addresses (TRACe:UDP? MAX) has been reached an error is generated: -310, "Maximum number of UDP addresses exceeded".

In case a tag is added to a UDP address that has flags that are incompatible with this tag (e.g. "FSTRength" flag and AUDio tag), these flags are ignored for those tags.

Parameters:

<ip-address> string representing IP dot notation of IP address (e.g. 172.17.75.18)
 <numeric_value> integer port number in the range [0,65535] (16 bit)
 <tag> See Table 19 for tags in Section 12.1.

Remark:

If the UDP-address is not in the list, it is added to it. Otherwise, it is modified

*RST state:

The "*RST" command has no effect on these settings.

After a power down, the UDP-address list only contains the default entry (index 0). The default is retained.

Example:

```
TRACe:UDP:TAG:ON "123.456.789.012", 5555, MSC, FSC
```

12 UDP Data Streams

This chapter describes the data streams that can be output by the Orion MR. All data streams have a similar (general) structure, which is described in Section 12.1. After that, each data stream is described in a separate section.

12.1 Stream Packet Structure

Each stream consists of a number of UDP packets, and each packet has a similar structure that is shown in Table 18. The first (light grey) part is the common header which is the same for all stream types. Its <attribute tag> determines the stream type, and its <trace selector flags> determines what data are included.

The <optional header> and the <trace data> are different for each stream type. Each stream type is further described in a separate section.

The <trace selector flags> shown in Table 20 define the data items that are included in a data stream. The Orion MR does not support all data items that the ESMB version of its predecessor, the EB200, supported. The following items are not supported: AM, AM_POS, AM_NEG, FM, FM_POS, FM_NEG, PM, and BANDWIDTH.

The data items as defined by the <trace selector flags> are not included automatically, but must be selected through an SCPI command (see TRACe:UDP:FLAGS). Not all items are possible with every data stream type. For every data stream type, the items that are allowed are mentioned explicitly.

Table 18: Stream Format (table is 4 bytes wide, data types are described in Table 19)

| 32-bit aligned | 8-bit aligned | 16-bit aligned | 8-bit aligned |
|---|---------------|-----------------------------|------------------------------|
| header magic_number | | | |
| header minor_version_number | | header major_version_number | |
| header sequence_number | | header reserved | |
| header reserved | | | |
| attribute tag | | attribute length | |
| trace number of items | | trace reserved | trace optional-header length |
| trace selector flags (see Table 20) | | | |
| optional header: Size and structure depend on the type of stream. Each stream type has its own section, see sections 12.2 to 12.8. | | | |
| trace data: Format depends on type of stream, see Sections 12.2 through to 12.8. | | | |

Table 19: Data Types

| Terminal | C Data Type | Remarks |
|--------------------------------|--------------------|---|
| <header magic number> | unsigned long | Always 0x000EB200 |
| <header minor version-number> | unsigned short | Version that is incremented for small changes in format that maintain compatibility. For the traces in this document, the minor version is “30”. |
| <header major version-number> | unsigned short | Constant specific for device Only incremented when changes in format cause incompatibility. For the traces in this document, the major version is “2”. |
| <header sequence number> | unsigned short | Incremented for each UDP packet sent. After reaching its highest value, it starts at 0 again. Each UDP address has its own sequence number. |
| <header reserved> | character[6] | not used |
| <attribute tag> | unsigned short | 101 = FSCan 201 = MSCan 401 = AUDio 501 = IFPan 801 = CW 901 = IF 1201 = PSCan |
| <attribute length> | unsigned short | number of bytes following this field: from <trace number of items> to “trace data” inclusive |
| <trace number of items> | short | number of measurements in <trace data>. E.g. a value of 100 with LEVEL and OFFSET selected, means there are 100 LEVEL values followed by 100 OFFSET values in <trace data>. |
| <trace reserved> | character | not used |
| <trace optional-header length> | unsigned character | number of bytes in <optional header> |
| <trace selector flags> | unsigned long | See Table 20 |

The data fields in the common header are always sent in Big Endian order (= most significant byte first).

For <optional header> and <trace data> the order is determined by the selector flag SWAP (see Table 20): if SWAP is not set the order is Big Endian, if set the order is Little Endian.

The selector flags OFFSET and FSTRENGTH shown in Table 20, only have an effect if the corresponding measurement functions are switched on:

OFFSET requires SENS:FUNC:ON "FREQUency:OFFSet"

FSTRENGTH requires SENS:FUNC:ON "FSTRength"

Note that LEVEL does not require the corresponding measurement function.

The selector flag CHANnel only contains the channel number when the frequency mode is MSCan or FSCAN. Otherwise, it contains the value zero.

Table 20: Settings for <trace selector flags>. The "C Data Type" column is the data type of the data that are included by setting the associated flag. It is not the data type of the flag itself.

| Selector Flag | Hex Value | C Data Type | SCPI parameter | Remarks |
|----------------------------|----------------|-------------------|---|---|
| LEVEL | 0x0000 0001 | short | "VOLTage:AC" | Unit:1/10 dB μ V |
| OFFSET | 0x0000 0002 | long | "FREQUency:O FFSet" | Unit: Hz |
| FSTRENGTH | 0x0000 0004 | short | "FSTRength" | Unit:1/10 dB μ V |
| CHANNEL | 0x0001 0000 | short | "CHANnel" | See SENS: MSC:CHA N |
| FREQ_LOW | 0x0002 0000 | unsigne d long | "FREQUency:R X" or "FREQUency:L OW:RX" | Unit: Hz |
| FREQ_HIGH | 0x0020 0000 | unsigne d long | "FREQUency:HI GH:RX" | Unit: Hz |
| SWAP | 0x2000 0000 | N.A. | "SWAP" | Data order: Little Endian if set; else Big Endian |
| SIGNAL_GREATER_S QUELCH | 0x4000 0000 | N.A. | "SQUelch" | Only data that exceed the squelch |

| | | | | |
|-----------------|----------------|------|------------|--|
| OPTIONAL_HEADER | 0x8000 0000 | N.A. | “OPTional” | level are included Optional header is included |
|-----------------|----------------|------|------------|--|

Note:

The Selector flag “FREQUENCY:LOW:RX” and “FREQUENCY:RX” are the same. The “FREQUENCY:RX” flag is compatible with the older receivers and supports frequencies < 4 GHz.

Since the PR100 frequency range is > 4 GHz a new flag FREQUENCY:HIGH:RX is introduced.

Backwards compatibility is realized by adding the higher 32 bits of a frequency at the end of the optional header.

Empty packets (also those with an optional header but without data) are not transmitted.

For packets that contain scan data (for FSCan, MSCan, and PSCan), the end of a sweep (scan) is marked: The last item in a scan is always followed by an end-marker. This end-marker is another item with unrealistic values:

Table 21, End Markers

| Data Type | Value | Unit |
|-----------|------------|--------------|
| LEVEL | 2000 | dB μ V |
| OFFSET | 10 000 000 | Hz |
| FSTRENGTH | 32 767 | dB μ V/m |
| CHANNEL | 0 | |
| FREQ_LOW | 0 | Hz |
| FREQ_HIGH | 0 | Hz |

Note that the end-marker is counted in the header field <trace number of items>. E.g.: An FSCan from 100 MHz to 110 MHz with a 1 MHz step width outputs 12 items: 11 measured items and 1 end-marker.

12.2 Audio

The audio stream is only active if SYST:AUD:REM:MODE has been set to anything else but 0 (zero). It is further determined by two parameters:

- Audio mode: determines the data-rate and the format of the audio samples
- Audio demodulation: determines the demodulation used to obtain the audio samples, e.g. AM or FM

The applicable selector flags (see Table 20) are “OPTIONAL_HEADER” and “SWAP”.

The header field <trace number of items> is the number of frames (see Table 25) in a packet.

Table 22: Audio Format <optional header> and <trace data>

| 32-bit aligned | 8-bit aligned | 16-bit aligned | 8-bit aligned |
|---|---------------|-----------------------------------|---------------|
| Audio mode | | Audio frame len | |
| Audio frequency low (4 bytes) | | | |
| Audio bandwidth | | | |
| Audio demodulation id | | Audio demodulation mode (8 bytes) | |
| | | Audio frequency high (4 bytes) | |
| | | reserved (2bytes)(| |
| trace data: see Table 25, depends on Audio mode | | | |

Table 23: Audio Data Types

| Terminal | C Data Type | Remarks |
|---------------------------|----------------|--|
| <AUDio audio mode> | short | See Table 25 (Format ID) |
| <AUDio frame len> | short | See Table 25 (Frame Length) |
| <AUDio frequency low> | unsigned long | Lower 32 bits of output of SENS:FREQ:CW? in Hz |
| <AUDio bandwidth> | unsigned long | Output of SENS:BAND:RES? in Hz |
| <AUDio demodulation id> | unsigned short | Output of SENS:DEM? acc. to Table 24 (Identifier column) |
| <AUDio demodulation mode> | char[8] | See column “Demodulation-Mode” in Table 24. |
| <AUDio frequency high> | unsigned long | Upper 32 bits of output of SENS:FREQ:CW? in Hz |

Table 24: Demodulation Modes and Identifiers (modes 0 – 6 are compatible with EB200)

| Demodulation-Mode | Identifier | Req. | EB200 |
|-------------------|------------|---------|------------|
| FM | 0 | SFD096 | Compatible |
| AM | 1 | SFD095 | Compatible |
| PULS | 2 | SFD0102 | Compatible |
| CW | 3 | SFD0100 | Compatible |
| USB | 4 | SFD097 | Compatible |
| LSB | 5 | SFD098 | Compatible |

| | | | |
|-----|---|---------|------------|
| IQ | 6 | SFD0101 | Compatible |
| ISB | 7 | SFD099 | New |

Table 25: Audio Data Formats (All Compatible with EB200, Req. SFD0247, except for the GSM format that is not supported in the Orion MR). Each channel is sampled at a certain rate (second column) with a number of bits accuracy (third column). There is one special format in this table, mode 0, in which no data is sent.

| Format ID | Sample Rate [kHz] | Bit per Sample | Channels | Data Rate [kByte/s] | Frame Length [Bytes] |
|-----------|-------------------|----------------|----------|---------------------|----------------------|
| 0 | - | - | - | 0 | - |
| 1 | 32 | 16 | 2 | 128 | 4 |
| 2 | 32 | 16 | 1 | 64 | 2 |
| 3 | 32 | 8 | 2 | 64 | 2 |
| 4 | 32 | 8 | 1 | 32 | 1 |
| 5 | 16 | 16 | 2 | 64 | 4 |
| 6 | 16 | 16 | 1 | 32 | 2 |
| 7 | 16 | 8 | 2 | 32 | 2 |
| 8 | 16 | 8 | 1 | 16 | 1 |
| 9 | 8 | 16 | 2 | 32 | 4 |
| 10 | 8 | 16 | 1 | 16 | 2 |
| 11 | 8 | 8 | 2 | 16 | 2 |
| 12 | 8 | 8 | 1 | 8 | 1 |

12.3 FScan

The Orion MR can provide 2000 measurements per second (minimum MEAS:TIME is 0.5 ms; Req. SFD0172). For each measurement, LEVEL, OFFSET, FSTRENGTH, CHANNEL, FREQ_LOW and FREQ_HIGH can be included into this stream, which is 16 bytes per measurement. All selector flags (see Table 20) are applicable for this stream. Data are output when FSCAN is running.

Table 26: FScan Format <optional header> and <trace data>.

| 32-bit aligned | 8-bit aligned | 16-bit aligned | 8-bit aligned |
|-------------------|---------------|-------------------------------------|---------------|
| FScan cycle count | | FScan hold time | |
| FScan dwell time | | FScan direction up | |
| FScan stop signal | | FScan start frequency low (4 bytes) | |

| | |
|---|--------------------------------------|
| | FScan stop frequency low (4 bytes) |
| | FScan frequency step (4 bytes) |
| | FScan start frequency high (4 bytes) |
| | FScan stop frequency high (4 bytes) |
| | reserved (2bytes) |
| trace data: (where n = <trace number of items>) | |
| n times short , in case <trace selector flags> has LEVEL set | |
| n times long , in case <trace selector flags> has OFFSET set | |
| n times short , in case <trace selector flags> has FSTRENGTH set | |
| n times short , in case <trace selector flags> has CHANNEL set | |
| n times unsigned long , in case <trace selector flags> has FREQ_LOW set | |
| n times unsigned long , in case <trace selector flags> has FREQ_HIGH set | |

Table 27: FScan Data Types

| Terminal | C Data Type | Remarks |
|---------------------------------|---------------|--|
| <FScan cycle count> | short | Output of “SENS:SWE:COUN?” Range: [1, 1000] Infinity: 1001 |
| <FScan hold time> | short | Output of “SENS:SWE:HOLD:TIME?” in ms |
| <FScan dwell time> | short | Output of “SENS:SWE:DWEL?” in ms Infinity: 65535 (0xFFFF) |
| <FScan direction up> | short | Output of “SENS:SWE:DIR?” acc. to 1 = Increasing frequency 0 = Decreasing frequency |
| <FScan stop signal> | short | Output of “SENS:SWE:CONT:ON?” acc, to 0 = Off 1 = On |
| <FScan start frequency low> | unsigned long | Lower 32 bits of output of “SENS:FREQ:STAR?” in Hz |
| <FScan stop frequency low> | unsigned long | Lower 32 bits of output of “SENS:FREQ:STOP?” in Hz |
| <FScan frequency step> | unsigned long | Output of “SENS:FREQ:STEP:INCR?” in Hz |
| <FScan start frequency high> | unsigned long | Upper 32 bits of output of “SENS:FREQ:STAR?” in Hz |
| <FScan stop frequency high> | unsigned long | Upper 32 bits of output of “SENS:FREQ:STOP?” in Hz |

12.4 MScan

The Orion MR can provide 2000 measurements per second (minimum MEAS:TIME is 0.5 ms; Req. SFD0172). For each measurement, LEVEL, OFFSET, FSTRENGTH, CHANNEL, FREQ_LOW and FREQ_HIGH can be included into this stream, which is 18 bytes per measurement.

All selector flags (see Table 20) are applicable for this stream

Data are output when MSCAN is running.

Table 28: MScan Format <optional header> and <trace data>.

| | | | |
|----------------|---------------|----------------|---------------|
| 32-bit aligned | 8-bit aligned | 16-bit aligned | 8-bit aligned |
|----------------|---------------|----------------|---------------|

| | |
|---|--------------------|
| MScan cycle count | MScan hold time |
| MScan dwell time | MScan direction up |
| MScan stop signal | reserved (2 bytes) |
| trace data: (where n = <trace number of items>): | |
| n times short , in case <trace selector flags> has LEVEL set | |
| n times long , in case <trace selector flags> has OFFSET set | |
| n times short , in case <trace selector flags> has FSTRENGTH set | |
| n times short , in case <trace selector flags> has CHANNEL set | |
| n times unsigned long in case <trace selector flags> has FREQ_LOW set | |
| n times unsigned long in case <trace selector flags> has FREQ_HIGH set | |

Table 29: MScan Data Types

| Terminal | C Data Type | Remarks |
|----------------------|--------------|--|
| <MScan cycle count> | short | Output of "SENS:MSC:COUN?" Range: [1, 1000] Infinity: 1001 |
| <MScan hold time> | short | Output of "SENS:MSC:HOLD:TIME?" in ms |
| <MScan dwell time> | short | Output of "SENS: MSC:DWEL?" in ms Infinity: 65535 (0xFFFF) |
| <MScan direction up> | short | Output of "SENS:MSC:DIR?": 1 = Increasing frequency 0 = Decreasing frequency |
| <MScan stop signal> | short | Output of "SENS:MSC:CONT:ON?": 0 = Off 1 = On |

12.5 CW

The Orion MR can provide 2000 measurements per second (minimum MEAS:TIME is 0.5 ms; Req. SFD0172). For each measurement, LEVEL, OFFSET, FSTRENGTH, CHANNEL, FREQ_LOW and FREQ_HIGH can be included into this stream, which is 16 bytes per measurement. All selector flags (see Table 20) are applicable for this stream.

Data are output when SENS:FREQ:MODE is CW and MEAS:MODE is PERiodic.

Table 30: CW Format: <optional header> and <trace data>

| | | | |
|-----------------------|----------------------|-----------------------|----------------------|
| 32-bit aligned | 8-bit aligned | 16-bit aligned | 8-bit aligned |
|-----------------------|----------------------|-----------------------|----------------------|

| |
|---|
| CW frequency low (4 bytes) |
| CW frequency high (4 bytes) |
| trace data: (where n = <trace number of items>) |
| n times short , in case <trace selector flags> has LEVEL set |
| n times long , in case <trace selector flags> has OFFSET set |
| n times short , in case <trace selector flags> has FSTRENGTH set |
| n times short , in case <trace selector flags> has CHANNEL set |
| n times unsigned long , in case <trace selector flags> has FREQ_LOW set |
| n times unsigned long , in case <trace selector flags> has FREQ_HIGH set |

Table 31: CW Data Types

| Terminal | C Data Type | Remarks |
|---------------------|----------------------|---|
| <CW frequency low> | unsigned long | Lower 32 bits of output of SENS:FREQ:CW in Hz |
| <CW frequency high> | unsigned long | Upper 32 bits of output of SENS:FREQ:CW in Hz |

12.6 IFPan

The IFPan stream contains the level information for all frequencies of an IF panorama (not just the visible ones). That way, a program on a remote client can display the panorama view itself in its own way. The number of frequencies in an IFPan packet varies with the screen resolution.

The applicable selector flags (see Table 20) are “LEVEL”, “SWAP” and “OPTIONAL_HEADER”.

Data are output when SENS:FREQ:MODE is CW. Each UDP packet contains exactly one IF panorama.

Table 32: IFPan Format: <optional header> and <trace data>

| 32-bit aligned | 8-bit aligned | 16-bit aligned | 8-bit aligned |
|---|---------------|--------------------|---------------|
| IFPan frequency low (4 bytes) | | | |
| IFPan span frequency (4 bytes) | | | |
| IFPan reserved | | IFPan average type | |
| IFPan measure time | | | |
| IFPan frequency high (4 bytes) | | | |
| trace data: (where n = <trace number of items>) | | | |
| n times short , in case <trace selector flags> has LEVEL set | | | |

Table 33: IFPan Data Types

| Terminal | C Data Type | Remarks |
|------------------------|---------------|---|
| <IFPan frequency low> | unsigned long | Lower 32 bit of center of IFPan span (“SENS:FREQ:CW?”) in Hz |
| <IFPan span frequency> | unsigned long | Output of “SENS:FREQ:SPAN?” in Hz |
| <IFPan reserved> | Short | Always 0; this field is not used |
| <IFPan average type> | Short | Always set to OFF (3), regardless of the output of “CALC:IFP:AVER:TYPE?”. |
| <IFPan measure time> | unsigned long | Output of “MEAS:TIME?” in μ s. 0 μ s is used for Default. |
| <IFPan frequency high> | unsigned long | Upper 32 bit of center of IFPan span (“SENS:FREQ:CW?”) in Hz |

12.7 IF

The IF stream contains source IQ data. Although the Audio stream can also contain data in IQ form, it is not the same as this stream. This stream is the source for the audio demodulation: The Audio IQ is obtained by processing this stream. For the IF stream, the data rate can be very high: 640 kSamples/second (Req. SFD0248). It has 2 channels and 16 bit per sample. At the maximum sample rate of 640k per second, the total data-rate is 2.56 MByte/s.

The only applicable selector flag is “OPTIONAL_HEADER”. All other flags have no influence on the format of the IF stream. Data is always sent with the SWAP flag set, independent of whether the SWAP flag has been configured for this stream or not.

Data are output when no PSCAN/FSCAN/MSCAN is running, and additionally also during the HOLD state in a running FSCAN/MSCAN.

Table 34: IF Format: <optional header> and <trace data>

| 32-bit aligned | 8-bit aligned | 16-bit aligned | 8-bit aligned |
|----------------------------|---------------|-----------------------|---------------|
| IF mode | | IF frame length | |
| IF sample rate | | | |
| IF frequency low (4 bytes) | | | |
| IF bandwidth | | | |
| IF demodulation id | | IF RX attenuation | |
| IF flags | | IF reserved (2 bytes) | |

| | |
|-------------------------------------|-------------------------------------|
| IF demodulation mode (8 bytes) | |
| IF sample count (8 bytes) | |
| IF frequency high (4 bytes) | |
| I sample nr 1 | Q sample nr 1 |
| I sample nr 2 | Q sample nr 2 |
| ... | ... |
| I sample nr <trace number of items> | Q sample nr <trace number of items> |

Table 35: IF Data Types

| Terminal | C Data Type | Remarks |
|------------------------|----------------|---|
| <IF mode> | short | Always 1 |
| <IF frame length> | short | Number of bytes for each IQ sample-pair: always 4. |
| <IF sample rate> | long | Sampling rate in samples/s |
| <IF frequency low> | unsigned long | Lower 32 bits of output of “SENS:FREQ:CW?” in Hz |
| <IF bandwidth> | unsigned long | Output of “SENS:BAND:RES?” in Hz |
| <IF demodulation id> | unsigned short | Output of SENS:DEM? acc. to Table 24 (Identifier column) |
| <IF RX attenuation> | short | Always 0 |
| <IF flags> | short | Validity flags: 0 during instrument settling, 1 otherwise |
| <IF reserved> | char[2] | reserved for 64-bit alignment |
| <IF demodulation mode> | char[8] | See column “Demodulation-Mode” in Table 24. |
| <IF sample count> | long long | Sequence number of first sample in packet |
| <IF frequency high> | unsigned long | Higher 32 bits of output of “SENS:FREQ:CW?” in Hz |

12.8 PSCAN

A PSCAN in consists of several FFT measurements in a row. Each FFT consists of x samples, where x depends on the “RF Panorama Scan Resolution BW. Max x = 3199 and Min x = 99 samples, with 16 bit per sample. The applicable selector flags (see Table 20) are “LEVEL”, “FREQ_LOW”, “FREQ_HIGH”, “SWAP” and “OPTIONAL_HEADER”.

Data are output when PSCAN is running. Note that each packet contains one single FFT. The Scan contains several FFT’s

Table 36: PScan Format: <optional header> and <trace data>

| 32-bit aligned | 8-bit aligned | 16-bit aligned | 8-bit aligned |
|--------------------------------------|---------------|----------------|---------------|
| PSCAN start frequency low (4 bytes) | | | |
| PSCAN stop frequency low (4 bytes) | | | |
| PSCAN step frequency (4 bytes) | | | |
| PSCAN start frequency high (4 bytes) | | | |

| PSCAN stop frequency high (4 bytes) | |
|---|---|
| FFT LEVEL nr 1 (in case <trace selector flags> has LEVEL set) | FFT LEVEL nr <trace number of items> (in case <trace selector flags> has LEVEL set) |
| FFT FREQUENCY LOW nr 1 (in case <trace selector flags> has FREQ_LOW set) | |
| FFT FREQUENCY LOW nr <trace number of items> (in case <trace selector flags> has FREQ_LOW set) | |
| FFT FREQUENCY HIGH nr 1 (in case <trace selector flags> has FREQ_HIGH set) | |
| FFT FREQUENCY HIGH nr <trace number of items> (in case <trace selector flags> has FREQ_HIGH set) | |

To indicate the end of the PSCAN, a unique “end marker” sample for each trace is inserted into the stream. The marker sample value depends on the trace and is specified in Table 21.

Note1:

Analyzer 2000 uses the trace selector flag LEVEL, FREQ_LOW and FREQ_HIGH to support frequencies > 4 GHz. Analyzer 2000 V5.05 + patch is required. The patch = RSRxDrv.dll date 9-oct-2007, size 92KByte

Note2:

Analyzer 2000 supports the PSCAN stream RUN+ only.

Table 37: PScan Data Types

| Terminal | C Data Type | Remarks |
|---------------------------------|---------------|---|
| <PSCAN start frequency low> | unsigned long | Lower 32 bits of output of "SENS:FREQ:STAR?" in Hz |
| <PSCAN stop frequency low> | unsigned long | Lower 32 bits of output of "SENS:FREQ:STOP?" in Hz |
| <PSCAN step frequency> | unsigned long | Output of "SENS:FREQ:STEP:INCR?" in Hz |
| <PSCAN start frequency high> | unsigned long | Higher 32 bits of output of "SENS:FREQ:STAR?" in Hz |
| <PSCAN stop frequency high> | unsigned long | Higher 32 bits of output of "SENS:FREQ:STOP?" in Hz |
| <PSCAN fft level> (x time) | short | Level (n) in dBuV |
| <PSCAN frequency low> (x time) | unsigned long | Lower 32 bits of the frequency of level (n) |
| <PSCAN frequency high> (x time) | unsigned long | higher 32 bits of the frequency of level (n) |

x = the FFT length. This depends on the RBW.

n = sample number. $0 \leq n < \text{FFT length}$

The start and stop frequency stored in the option header are the start and stop frequency the user has configured for PSCAN. The first sample of the PSCAN stream will be the level at the start frequency. Since it is possible to configure a stop frequency which is not a multiple of the PSCAN RBW, the last sample is not measured at the PSCAN stop frequency. The PR100 will round off the PSCAN nrOfSamples to + 1 if the span is not a multiple of the PSCAN RBW. For the PR100 PSCAN stream client knows the frequency of a level by:
Assuming the scan direction is RUN(+)

- 1) Use the trace selector flag `FREQ_LOW` and `FREQ_HIGH`.
- 2) If the trace selector flag `FREQ_LOW` and `FREQ_HIGH` are not used by:

$$f(\text{level } n) = f(\text{start}) + n \cdot \text{RBW}$$

where:

n = PSCAN sample number, starting from 0 at the PSCAN start frequency.

$f(\text{start})$ = PSCAN start frequency,

RBW = "RF Panorama Scan Resolution BW"

Figure 5 shows the payload of a PSCAN UDP package where the trace selector flags “LEVEL”, “FREQ_LOW”, “FREQ_HIGH”, and “OPTIONAL_HEADER” are set.

A PSCAN cycle is a single scan from start till the stop frequency.

The last sample of a cycle will be the “end marker” value.

A single PSCAN cycle consist of 1 or more PSCAN UDP packages.

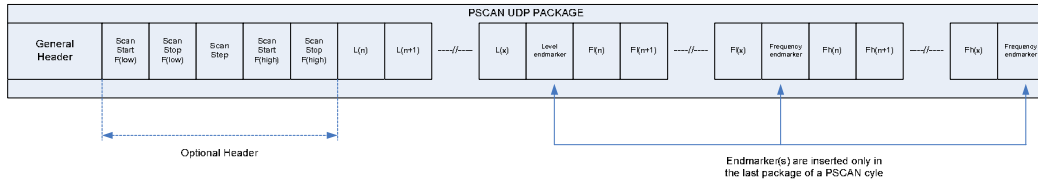

Figure 5 Payload PSCAN UDP Package

Note

The PSCAN stream is available during a running PSCAN only.

- To enable a PSCAN stream including LEVEL, FREQ_LOW and FREQ_HIGH:
If stream client is 172.17.75.50:19000 :
Trace:Udp:Tag:On "172.17.75.50", 19000, PSCAN
Trace:udp:flag:on "172.17.75.1", 19000, "FREQ:LOW:rx", "FREQ:HIG:rx", "VOLT:AC"
- To get an overview of all UDP streams:
Trace:udp?
- To delete all UDP streams:
trace:Udp>Delete ALL

13 Default Values

CALCulation subsystem

| Description | Command [CALC:] | Factory Default | Min | Max | Unit | *RST | PWR ON |
|--------------------|-----------------|-----------------|-----|-----|------|------|--------|
| IFPAN Average type | IFP:AVER:TYPE | MAX | NA | NA | enum | + | - |
| PSCAN Average type | PSC:AVER:TYPE | MAX | NA | NA | enum | + | - |

13.1 DISPlay subsystem

| Item | Command [DISP:] | Factory Default | Min | Max | Unit | *RST | PWR ON |
|-----------------------------------|-----------------|-----------------|-------|-------|-------|------|--------|
| Display auto off | AUTO:OFF | ? | | | bool | + | - |
| Brightness | BRIG | 0.5 | 0.01 | 1.0 | steps | + | - |
| Switch on time backlight | BRIG:DWEL | 0 | | | s | + | - |
| Color map | CMAP | IND | | | enum | + | - |
| Date format | DATE:FORM | DDMM | | | date | - | - |
| Display disable | DIS | 0 | | | bool | + | - |
| Display enable | ENAB | 1 | | | bool | + | - |
| Display frequency information | FREQ:OFFS | SYMB | | | - | + | - |
| Display fieldstrength information | FSTR | 0 | | | bool | + | - |
| IFPAN level range | IFP:LEV:RANG | 60.0 | 10.0 | 140.0 | steps | + | - |
| IFPAN signal level max | IFP:LEV:REF | 50.0 | -30.0 | 110.0 | dBµV | + | - |
| Level bar lower limit | LEV:LIM:MIN | -10.0 | -30.0 | 110.0 | dBµV | + | - |
| Level bar range | LEV:RANG | 60.0 | 30.0 | 90.0 | dB | + | - |
| PSCAN signal level range | PSC:LEV:RANG | 60.0 | 10.0 | 140.0 | dB | + | - |
| PSCAN signal level max | PSC:LEV:REF | 50.0 | -30.0 | 110.0 | dBµV | + | - |

| | | | | | | | |
|----------------------------------|---------------|-------------|------|-------|------------|---|---|
| Waterfall signal level range | WAT:CMAP:RANG | 60.0 | 10.0 | 140.0 | dB | + | - |
| Waterfall signal level threshold | WAT:CMAP:THR | 50 | -30 | 110 | dB μ V | + | - |
| Waterfall hold | WAT:HOLD | 1 | 0 | 1 | bool | + | - |
| Waterfall speed | WAT:SPEE | 20 | | | lines/s | + | - |
| Window mode | WIND | RX+Spectrum | | | enum | + | - |

13.2 FORMat subsystem

| Item | Command [FORM:] | Factory Default | Min | Max | Unit | *RST | PWR ON |
|-----------------------------|-----------------|-----------------|-----|-----|------|------|--------|
| Binary data byte order | BORD | NORM | NA | NA | NA | + | + |
| Binary output data format | DATA | ASC | NA | NA | NA | + | + |
| Binary memory data format | MEM | ASC | NA | NA | NA | + | + |
| Status register data format | SREG | ASC | NA | NA | NA | + | + |

13.3 INPut subsystem

| Item | Command [INP:] | Factory Default | Min | Max | Unit | *RST | PWR ON |
|-------------------|----------------|-----------------|-----|-----|------|------|--------|
| Input attenuation | ATT | 0 | 0 | 1 | bool | + | - |

13.4 MEASurement subsystem

| Item | Command [MEAS:] | Factory Default | Min | Max | Unit | *RST | PWR ON |
|------------------|-----------------|-----------------|------|------|------|------|--------|
| Measurement Mode | MODE | CONT | None | None | enum | + | - |
| Measurement Time | TIME | DEF | 0.5m | 900 | s | + | - |

13.5 MEMory subsystem

| Item | Command: [MEM:] | Factory Default | Min | Max | Unit | *RST | PWR ON |
|--------------------------------|-----------------|-----------------|-----|------|------|------|--------|
| First memory save location | SAVE:AUTO:STAR | 800 | 0 | 1023 | | + | - |
| Last memory save location | SAVE:AUTO:STOP | 999 | 0 | 1023 | | + | - |
| First mem save location direct | SAVE:DIR:STAR | 600 | 0 | 1023 | | + | - |
| Last mem save location direct | SAVE:DIR:STOP | 799 | 0 | 1023 | | + | - |

13.6 OUTPut subsystem

| Item | Command: [OUTP:] | Factory Default | Min | Max | Unit | *RST | PWR ON |
|------------------------|------------------|-----------------|-------|-------|------------|------|--------|
| antenna selection bits | BITA:STAT | 0 | - | - | - | + | - |
| Antenna selection bits | BYTA:STAT | 0 | - | - | - | + | - |
| IF state | IF:STAT | 0 | - | - | bool | + | - |
| Squelch from memory | SQU:CONT | NONE | - | - | enum | + | - |
| Squelch state | SQU:STAT | 0 | - | - | bool | + | - |
| Squelch autosave | SQU:STOR | 0 | - | - | bool | + | - |
| Squelch threshold | SQU:THR | 0.0 | -30.0 | 110.0 | dB μ V | + | - |
| Tone control | TONE:CONT | ONLY | - | - | enum | + | - |
| Tone gain | TONE:GAIN | - | - | - | oct/dB | + | - |
| Tone state | TONE:STAT | 0 | - | - | bool | + | - |
| Tone threshold | TONE:THR | 0.0 | -14.0 | 94.0 | dB μ V | + | - |

13.7 SENSE subsystem

| Item | Command: [SENS:] | Factory Default | Min | Max | Unit | *RST | PWR ON |
|--------------------------------|------------------|-----------------|-----|------|------|------|--------|
| Current IF bandwidth | BAND | 150k | 150 | 500k | Hz | + | - |
| Selected antenna correction | CORR:ANT | PASS | - | - | enum | + | - |
| Demodulation type | DEM | FM | - | - | enum | + | - |
| Beat frequency | DEM:BFO:FREQ | 1k | -8k | 8k | Hz | + | - |
| Detector function | DET | PEAK | - | - | enum | + | - |
| AFC function | FREQ:AFC | 0 | - | - | bool | + | - |
| Frequency conversion threshold | FREQ:CONV:THR | 25M | 9k | 30M | Hz | + | - |
| RX frequency | FREQ | 100M | 9k | 7.5G | Hz | + | - |
| Receiver mode | FREQ:MODE | CW | - | - | enum | + | - |
| PSCAN frequency center | FREQ:PSC:CENT | - | - | - | - | + | - |
| PSCAN frequency span | FREQ:PSC:SPAN | - | - | - | - | + | - |
| PSCAN frequency start | FREQ:PSC::STAR | 88M | 9K | 100G | Hz | + | - |
| PSCAN frequency stop | FREQ:PSC::STOP | 108M | 9K | 100G | Hz | + | - |

| | | | | | | | |
|------------------------------------|---------------|-----------|-----|----------|--------|---|---|
| IFPAN frequency span | FREQ:SPAN | 10M | 10k | 10M | Hz | + | - |
| FSCAN frequency start | FREQ:STAR | 88M | 9K | 100G | Hz | + | - |
| FSCAN frequency stop | FREQ:STOP | 108M | 9K | 100G | Hz | + | - |
| Detector functions concurrent | FUNC:CONC | 1 | - | - | bool | + | - |
| Detector functions off | FUNC:OFF | (1) | - | - | string | + | - |
| Detector functions off counter | FUNC:OFF:COUN | 3 | - | - | - | + | - |
| Detector functions on | FUNC:ON | "" | - | - | string | + | - |
| Detector functions on counter | FUNC:ON:COUN | 0 | - | - | - | + | - |
| Gain control | GCON | 50 | -30 | 110 | dB | + | - |
| Gain control mode | GCON:MODE | AUTO | - | - | enum | + | - |
| MSCAN current mem location | MSC:CHAN | 0 | - | - | - | + | - |
| MSCAN control mechanisms off | MSC:CONT:OFF | "" | - | - | string | + | - |
| MSCAN control mechanisms on | MSC:CONT:ON | STOP:SIGN | - | - | string | + | - |
| MSCAN number of scans | MSC::COUN | INF | 1 | 1000/INF | - | + | - |
| MSCAN scan direction | MSC:DIR | UP | - | - | enum | + | - |
| MSCAN dwell time | MSC:DWEL | 0.5 | 0.0 | 60.0/INF | s | + | - |
| MSCAN hold time | MSC:HOLD:TIME | 0.0 | 0.0 | 60.0 | s | + | - |
| MSCAN memory list start | MSC:LIST:STAR | 0 | - | - | - | + | - |
| MSCAN memory list stop | MSC:LIST:STOP | 99 | - | - | - | + | - |
| PSCAN number of scans | PSC:COUN | INF | 1 | 1000/INF | - | + | - |
| PSCAN FFT bin width | PSC:STEP | 12.5k | 125 | 100k | Hz | + | - |
| Oscillator ext reference frequency | ROSC:EXT:FREQ | - | - | - | Hz | + | - |
| Oscillator int reference frequency | ROSC:INT:FREQ | - | - | - | Hz | + | - |
| Oscillator source | ROSC:SOUR | INT | - | - | enum | + | - |
| FSCAN control mechanisms off | SWE:CONT:OFF | "" | - | - | string | + | - |
| FSCAN control mechanisms on | SWE:CONT:ON | STOP:SIGN | - | - | string | + | - |
| FSCAN number of scans | SWE::COUN | INF | 1 | 1000/INF | - | + | - |
| FSCAN scan direction | SWE:DIR | UP | - | - | enum | + | - |
| FSCAN dwell time | SWE:DWEL | 0.5 | 0.0 | 60.0/INF | s | + | - |
| FSCAN hold time | SWE:HOLD:TIME | 0.0 | 0.0 | 60.0 | s | + | - |
| FSCAN step | SWE:STEP | 100k | 1 | 1G | Hz | + | - |

13.8 STATus subsystem

| Item | Command: [STAT:] | Factory Default | Min | Max | Unit | *RST | PWR ON |
|-------------------------------|------------------|-----------------|-----|-------|--------|------|--------|
| operation condition section | OPER:COND | 0 | 0 | 65535 | value | - | - |
| operation enable section | OPER:ENAB | 0 | 0 | 65535 | value | - | + |
| operation event section | OPER:EVEN | 0 | 0 | 65535 | value | - | + |
| operation negative transition | OPER:NTR | 0 | 0 | 65535 | value | - | + |
| operation positive transition | OPER:PTR | 65535 | 0 | 65535 | value | - | + |
| error queue | QUE | 0,"No error" | - | - | string | - | + |

13.9 SYSTem subsystem

| Item | Command: [SYST:] | Factory Default | Min | Max | Unit | *RST | PWR ON |
|----------------------------|-------------------|-----------------|------|-------|--------|------|--------|
| audio balance | AUD:BAL | 0.0 | -0.5 | 0.5 | - | + | - |
| audio volume | AUD:VOL | 0.30 | 0.00 | 1.00 | - | + | - |
| audio output | AUD:OUTP | - | - | - | - | + | - |
| audio digital AF mode | AUD:REM:MOD | - | - | - | - | + | - |
| beep volume | BEEP:VOL | 0.30 | 0.00 | 1.00 | - | + | - |
| LAN MAC address | COMM:LAN:ETH | mac address | - | - | - | - | - |
| LAN submask | COMM:LAN:SUBM | 255.255.255.0 | - | - | - | - | - |
| LAN socket address | COMM:SOCK:ADDR | 172.17.75.1 | - | - | - | - | - |
| LAN DHCP protocol enabled | COMM:SOCK:DHCP | 0 | - | - | bool | - | - |
| LAN socket port | COMM:SOCK:PORT | 5555 | 0 | 65535 | 16 bit | - | - |
| keyclick volume | KCL:VOL | - | - | - | - | - | - |
| userinterface manual state | KLOC | - | - | - | - | - | - |
| language | LANG:CAT | - | - | - | - | - | - |
| password protection | PASS:STAT | - | - | - | - | - | - |
| power off time | POW:AUTO:OFF:TIME | - | - | - | - | - | - |

13.10 TRACe subsystem

| Item | Command: [TRAC:] | Factory Default | Min | Max | Unit | *RST | PWR ON |
|-----------------------|------------------|-----------------|-----|-----|------|------|--------|
| data catalog | CAT | - | - | - | - | - | - |
| data memory fill mode | FEED:CONT | - | - | - | - | - | - |